

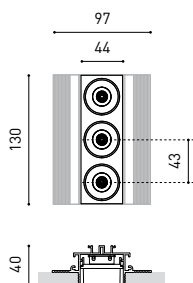

DIMENSIONS



ACCESSORIES



CUSTOM & MOUNTING
ACCESSORIES (MANDATORY)



DRIVER OPTIONS (MANDATORY)

AWARDS



PRODUCT	
Name	BLACK FOSTER 3 3000K N
Reference	A3173001N
Color	Matt black
RAL	9005
Category	CUSTOM SYSTEMS
LIGHTING INFORMATION	
Light source	LED
Gross luminous flux	630 Lm
Power	6,3 W
Power values of the system	7,99 W
Colour temperature	3000 K
Colour Rendering Index	CRI>90
Chromatic stability	Mac Adam Step 3
Light beam angle	38°
Unified Glare Rating	UGR<19
Lighting efficiency	90%
Efficacy	100 Lm/W
Current intensity	700 mA
Dimming	Please Consult
Control through bluetooth	Please Consult
Driver	Excluded
Emergency power supply	Please Consult
Electrical insulation class	III
Voltage	220 V/240 V
Frequency	50/60 Hz
Energy efficiency	A+
LED lifespan	L80B10 (Tc=85°C) >60.000h
OTHER DATA	
Ingress Protection	IP20
Weight	240 g.
Packaged weight	335 g.
Packaging dimensions	212 × 155 × 73 mm.
Units per package	1
Materials	Aluminium / Acrylonitrile Butadiene Styrene / Polycarbonate



Black Foster is the lighting fixture that transfers the applauded "Invisible Black" effect to a linear system. Black Foster is composed of a series of combinable modules enabling the alternation of segments with light emission and without light emission. However, whether it is ON or OFF, this luminaire always keeps the aesthetics of a perfect dark line. To the observer, it is impossible to distinguish between Black Foster parts that emit light from those that don't. Black Foster's modularity provides a wide range of different combinations, allowing to set up the light emission location as many times as needed, and adapting itself to the requirements of each project in particular.

POLAR DIAGRAM



CONICAL DIAGRAM

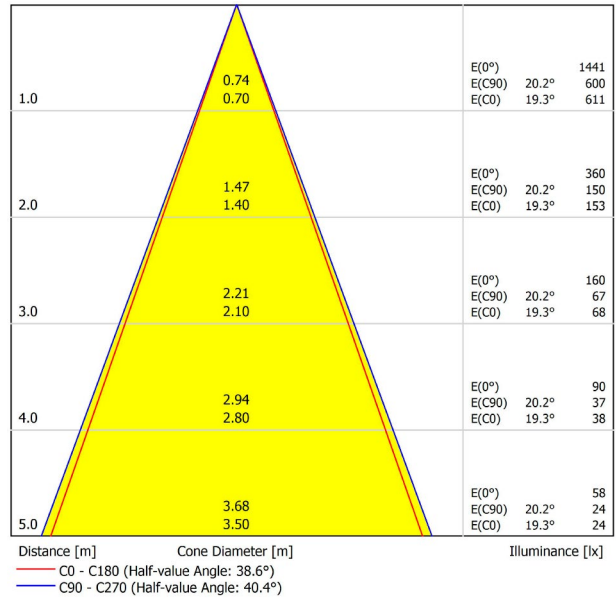

UGR

Glare Evaluation According to UGR											
ρ Ceiling	70	70	50	50	30	70	70	50	50	30	
ρ Walls	50	30	50	30	30	50	30	50	30	30	
ρ Floor	20	20	20	20	20	20	20	20	20	20	
Room Size X Y	Viewing direction at right angles to lamp axis					Viewing direction parallel to lamp axis					
2H	2H	-11.4	-10.8	-11.2	-10.6	-10.4	-11.5	-10.9	-11.3	-10.7	-10.5
	3H	-6.4	-5.9	-6.2	-5.6	-5.4	-5.6	-5.0	-5.3	-4.7	-4.5
	4H	-3.4	-2.9	-3.1	-2.6	-2.4	-2.2	-1.6	-1.9	-1.4	-1.1
	6H	-0.0	0.5	0.3	0.7	1.0	1.4	1.9	1.7	2.2	2.5
	8H	1.7	2.2	2.1	2.5	2.8	3.2	3.7	3.5	4.0	4.3
4H	12H	3.7	4.1	4.0	4.4	4.7	5.1	5.6	5.5	5.9	6.2
	2H	-9.8	-9.2	-9.5	-9.0	-8.7	-9.8	-9.3	-9.5	-9.0	-8.8
	3H	-4.7	-4.2	-4.3	-3.9	-3.6	-4.0	-3.5	-3.6	-3.2	-2.9
	4H	-1.6	-1.3	-1.3	-0.9	-0.6	-0.6	-0.2	-0.2	0.1	0.5
	6H	1.8	2.2	2.2	2.5	2.9	3.1	3.4	3.5	3.8	4.1
8H	8H	3.7	4.0	4.1	4.3	4.7	5.0	5.3	5.4	5.6	6.0
	12H	5.7	5.9	6.1	6.3	6.7	7.0	7.3	7.5	7.7	8.1
	4H	-0.4	-0.1	0.0	0.3	0.7	0.3	0.6	0.8	1.0	1.4
	6H	3.2	3.5	3.7	3.9	4.3	4.2	4.4	4.7	4.9	5.3
	8H	5.2	5.4	5.7	5.8	6.3	6.3	6.5	6.7	6.9	7.4
12H	12H	7.4	7.5	7.9	8.0	8.5	8.5	8.7	9.0	9.1	9.6
	4H	0.2	0.4	0.6	0.8	1.2	0.7	1.0	1.1	1.4	1.8
	6H	3.8	4.0	4.3	4.4	4.9	4.6	4.8	5.1	5.2	5.7
8H	5.8	6.0	6.3	6.4	6.9	6.8	6.9	7.3	7.4	7.9	
Variation of the observer position for the luminaire distances S											
S = 1.0H	+0.7 / -0.3					+1.3 / -0.4					
S = 1.5H	+1.4 / -0.5					+2.7 / -0.7					
S = 2.0H	+2.4 / -0.8					+4.2 / -0.9					
Standard table	---					---					
Correction Summand	---					---					
Corrected Glare Indices referring to 630lm Total Luminous Flux											

L

BLACK FOSTER Custom	Gap Corner 90°	A317-00-07- N 	200 x 200mm
	Gap 250	A317-00-01- N 	250mm
	Gap 500	A317-00-02- N 	500mm
	Gap 1000	A317-00-03- N 	1000mm
	Gap 2000	A317-00-04- N 	2000mm

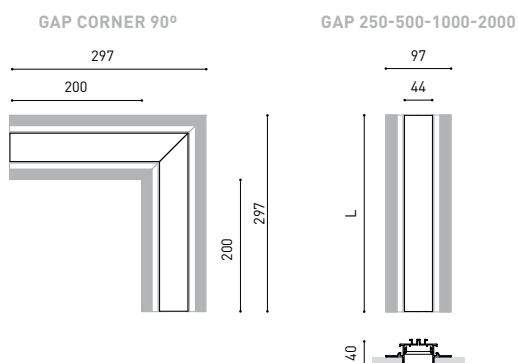

BLACK FOSTER End Caps Kit	A317-00-05- N 	Thickness of each cover 2mm.
----------------------------------	--------------------------	------------------------------



BLACK FOSTER Straight Joiner	A317-00-06	
-------------------------------------	-------------------	--



COLOUR | **N ■ RAL 9005** |

MATERIAL | AL | ABS+PC |

BLACK FOSTER Track Clamp Kit A219-21-20- | B |



BLACK FOSTER Flush Ceiling Kit A219-22-06- | B |



BLACK FOSTER Track Clamp Kit for M6 ROD A219-21-21- | B |



BLACK FOSTER Suspension Kit A219-21-10- | B |

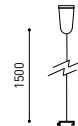

SUGGESTED MOUNTING ACCESSORIES QUANTITIES

Black Foster custom 2, 3, 5: 1Pcs.



Black Foster custom 10, 15: 2Pcs.

Gap 250, 500, 1000: 2Pcs.

Gap 2000: 4Pcs.

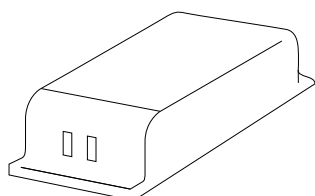
COLOUR | B □ |



DRIVER OPTIONS*		P	I	D
 NO DIM	0434-01-18	50W	700mA	124 x 79 x 22mm
 DALI Push / 1-10V	0433-00-23	50W	700mA	124 x 79 x 22mm

Connect in series only in order to keep a constant current.