

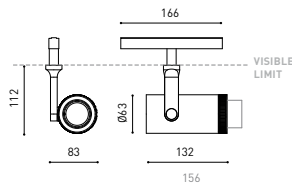

DIMENSIONS



ACCESSORIES



HIGH CHROMATIC LED



TRACK 48V OPTIONS

AWARDS



PREMIO
ADCV 2019
ORO

Name	PLUS 48V DIM DALI 4000K WT
Reference	A3230022WT
Color	Textured white
Power of the system	9016
Category	TRACKLIGHTS

LIGHTING INFORMATION

Light source	LED
Gross luminous flux	2030 Lm
Power	18 W
Power values of the system	19,25 W
Colour temperature	4000 K
Colour Rendering Index	CRI>90
Chromatic stability	Mac Adam Step 2
Light beam angle	12°-51°
Lighting efficiency	26-40%
Efficacy	113 Lm/W
Current intensity	500 mA
Dimming	DALI
Control through bluetooth	Please Consult
Driver	Included
Electrical insulation class	III
Voltage	48 Vdc
Energy efficiency	A
LED lifespan	L80B10 (Tj=85°C) >60.000h

OTHER DATA

Ingress Protection	IP20
Swivel angle	180°
Rotation angle	360°
Track type	Track 48V
Weight	583 g.
Packaged weight	705 g.
Packaging dimensions	225 x 191 x 84 mm.
Units per package	1
Materials	Aluminium / Optical Glass



Plus 48V is a spotlight for low voltage tracklight applications that offers the possibility of expanding or concentrating the beam light with just a smooth manual gesture. This characteristic makes Plus the ideal alternative for applications where the precision within the beam of light is essential- like for example: museums, exhibitions, retail or accent lighting applications.

POLAR DIAGRAM

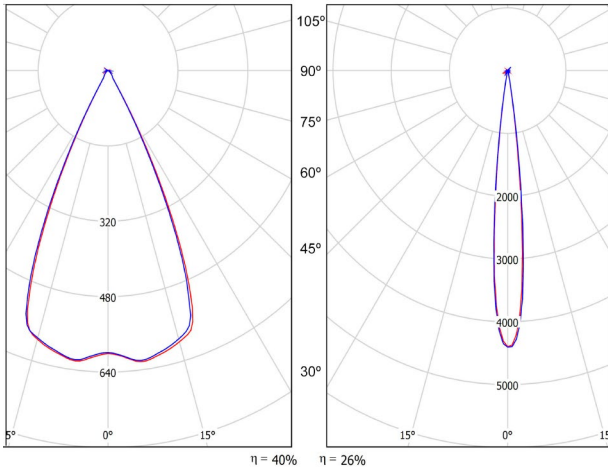

cd/klm

— C0 - C180 — C90 - C270

CONICAL DIAGRAM

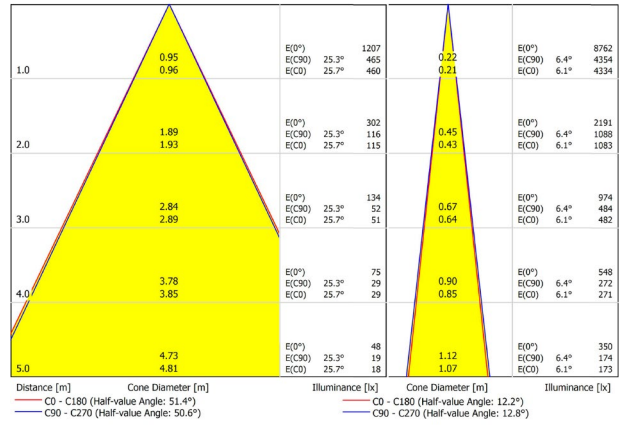

Vivid Model Colour Temperature	2700K	3000K	3500K	4000K	Light Pink
📖 Reading			•	•	
🥗 Fruits & Vegetables		•	•		
🍞 Bakery	•				
👤 Retail		•	•		
💄 Cosmetics			•	•	
🥩 Meat					•
🐟 Fish				•	
🐠 Seafood				•	•



For some of its products, Arkoslight offers the possibility to provide them with a special LED, designed to create an illumination focused on visually promoting goods or products for commercial purposes. It is a high chromaticity LED, capable of identifying the colour shades that produce a positive psychological perception of the illuminated object.

This special LED lighting source offers a much more attractive and intense colour range than a conventional LED, besides being much wider. Technically, this is possible thanks to a special LED setting that includes a «special saturation parameter», capable of highlighting the objects colours and materials in such a way that they seem more attractive within the visible light spectrum. To achieve this performance, in each case, the appropriate diode and specific phosphor coating are carefully selected.

TRACK 48V TRIMLESS

ARKOSLIGHT®

TRACK 48V SURFACE

Available on request. Please consult.

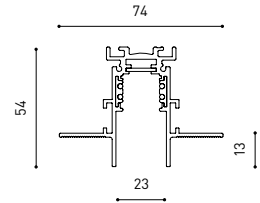

TRACK 48V 1M	A338-01-00- N
TRACK 48V 2M	A338-02-00- N
TRACK 48V 3M	A338-03-00- N
TRACK 48V Corner 90° One Plane	A338-06-00- N
TRACK 48V Corner 90° Two Planes	A338-07-00- N

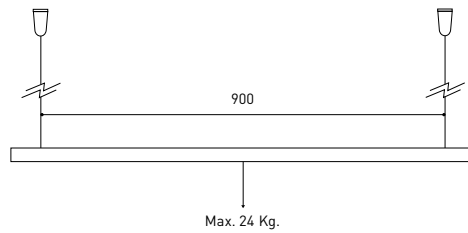

		P	I	D
CONSTANT VOLTAGE LED POWER SUPPLY	0434-01-21	75W	48V	180 x 52 x 30mm
	0434-01-22	150W	48V	240 x 60 x 49mm
	0434-01-19	75W	48V	235 x 100 x 31mm
	0434-01-20	150W	48V	235 x 100 x 31mm

CABLE SECTION AND LENGTH BETWEEN TRACK 48V AND POWER SUPPLY

TRACK LENGTH (m)		10			20		29
CABLE LENGTH (m)		1	10	20	1	10	1
POWER (W)	CABLE SECTION (mm²)						
75W	0,75mm²	✓	✓	✓	✓	✓	✓
	1,5mm²	✓	✓	✓	✓	✓	✓
150W	0,75mm²	✓	X	X	✓	X	✓
	1,5mm²	✓	✓	X	✓	✓	✓

COLOUR | N ■ RAL 9005 |

Recommended for installations where the profile can be installed before the false plasteboard ceiling (thickness 12,5mm.)



TRACK 48V TRIMLESS

ARKOSLIGHT®

TRACK 48V SURFACE

Available on request. Please consult.

TRACK 48V 90° CORNER One Plane

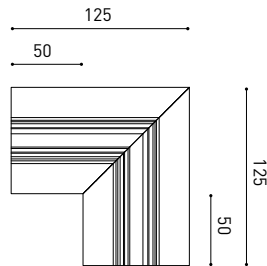

*Electrical connection not included

TRACK 48V 90° CORNER Two Planes

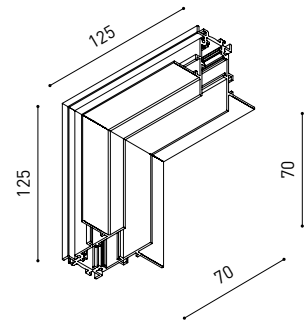

*Electrical connection not included

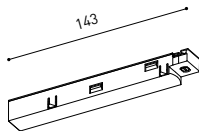

TRACK 48V Live-End Connector

A338-00-01- | N |



TRACK 48V End

A338-00-06- | N |

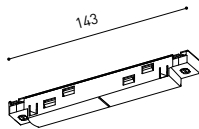

TRACK 48V Central Connector

A338-00-02- | N |



TRACK 48V End Feed

A338-00-07- | N |

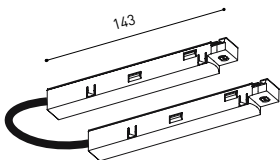

TRACK 48V Corner 90° Connector

A338-00-12

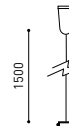

TRACK 48V Suspension Kit

A338-00-08

See accessories quantities*



TRACK 48V Short T-Bracket

A338-00-03



TRACK 48V Clamp for M6 ROD

A338-00-09

See accessories quantities*

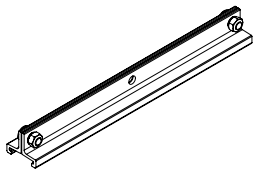

TRACK 48V Long T-Bracket

A338-00-04



TRACK 48V Track Clamp

A338-00-10

See accessories quantities*

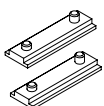

TRACK 48V Straight Joiners (2 Units)

A338-00-05

* SUGGESTED MOUNTING ACCESSORIES QUANTITIES

1000 mm - 2 Pcs.
2000 mm - 3 Pcs.
3000 mm - 4 Pcs.

COLOUR | N ■ RAL 9005 |

Recommended for installations where the profile can be installed before the false plasteboard ceiling (thickness 12,5mm.)