

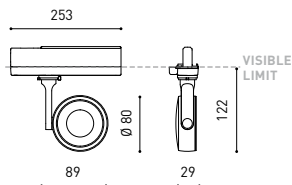

## DIMENSIONS



## ACCESSORIES



HIGH CHROMATIC LED



TRACK 3L OPTIONS

## AWARDS



## PRODUCT

|           |                               |
|-----------|-------------------------------|
| Name      | SIX M 2 DIM DALI 19° 2700K NT |
| Reference | A3312210NT                    |
| Color     | Textured black                |
| RAL       | 9005                          |
| Category  | TRACKLIGHTS                   |

## LIGHTING INFORMATION

|                             |                           |
|-----------------------------|---------------------------|
| Light source                | LED                       |
| Gross luminous flux         | 2050 Lm                   |
| Power                       | 17 W                      |
| Power values of the system  | 19,77 W                   |
| Colour temperature          | 2700 K                    |
| Colour Rendering Index      | CRI>90                    |
| Chromatic stability         | Mac Adam Step 2           |
| Light beam angle            | 19°                       |
| Lighting efficiency         | 93%                       |
| Efficacy                    | 84 Lm/W                   |
| Current intensity           | 500 mA                    |
| Dimming                     | DALI                      |
| Control through bluetooth   | Please Consult            |
| Driver                      | Included                  |
| Electrical insulation class | <input type="checkbox"/>  |
| Voltage                     | 220 V/240 V               |
| Frequency                   | 50/60 Hz                  |
| Energy efficiency           | A                         |
| LED lifespan                | L80B10 (Tj=85°C) >60.000h |

## OTHER DATA

|                      |                           |
|----------------------|---------------------------|
| Ingress Protection   | IP20                      |
| Swivel angle         | 310°                      |
| Rotation angle       | 350°                      |
| Track type           | Track 3L+N Dimmable       |
| Weight               | 415 g.                    |
| Packaged weight      | 540 g.                    |
| Packaging dimensions | 309 x 195 x 62 mm.        |
| Units per package    | 1                         |
| Materials            | Aluminium / Polycarbonate |



Six is a spotlight for either track or single recessed installation, standing out by its optical lightness and elegance. Its body comes in shape of a disk with a slightly convex rim that encloses an innovative combination of reflector and lens. The joint action of both achieves to direct the light beam with maximum uniformity in a minimum distance, which at the same time allowed the differentiated design of Six, compact and minimalist. The Six spotlight range is available from the XS to the XL size, with versions suitable for low and high voltage tracks, recessed versions, and "double" versions, composed of 2 contiguous elements.

POLAR DIAGRAM

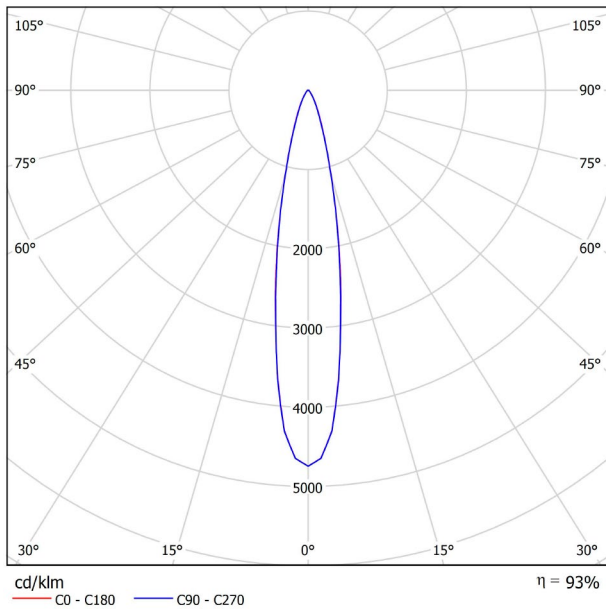

CONICAL DIAGRAM

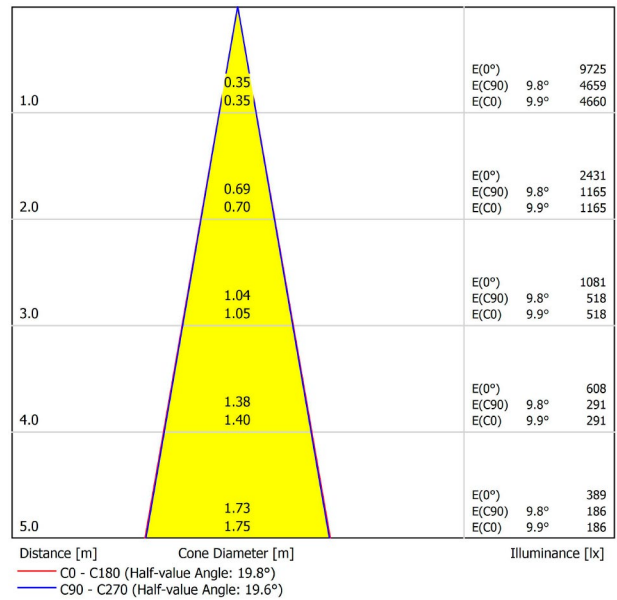

| Vivid Model<br>Colour Temperature | 2700K | 3000K | 3500K | 4000K | Light Pink |
|-----------------------------------|-------|-------|-------|-------|------------|
| 📖 Reading                         |       |       | •     | •     |            |
| 🥗 Fruits & Vegetables             |       | •     | •     |       |            |
| 🍞 Bakery                          | •     |       |       |       |            |
| 👤 Retail                          |       | •     | •     |       |            |
| 💄 Cosmetics                       |       |       | •     | •     |            |
| 🥩 Meat                            |       |       |       |       | •          |
| 🐟 Fish                            |       |       |       | •     |            |
| 🐠 Seafood                         |       |       |       | •     | •          |



For some of its products, Arkoslight offers the possibility to provide them with a special LED, designed to create an illumination focused on visually promoting goods or products for commercial purposes. It is a high chromaticity LED, capable of identifying the colour shades that produce a positive psychological perception of the illuminated object.

This special LED lighting source offers a much more attractive and intense colour range than a conventional LED, besides being much wider. Technically, this is possible thanks to a special LED setting that includes a «special saturation parameter», capable of highlighting the objects colours and materials in such a way that they seem more attractive within the visible light spectrum. To achieve this performance, in each case, the appropriate diode and specific phosphor coating are carefully selected.

TRACK 3L+N SURFACE & SUSPENDED



|             |             |   |   |
|-------------|-------------|---|---|
| TRACK 3L 1M | A219-21-01- | B | N |
| TRACK 3L 2M | A219-21-02- | B | N |
| TRACK 3L 3M | A219-21-03- | B | N |



TRACK 3L+N FLUSH MOUNTING



|                   |             |   |   |
|-------------------|-------------|---|---|
| TRACK 3L FLUSH 1M | A219-22-01- | B | N |
| TRACK 3L FLUSH 2M | A219-22-02- | B | N |
| TRACK 3L FLUSH 3M | A219-22-03- | B | N |

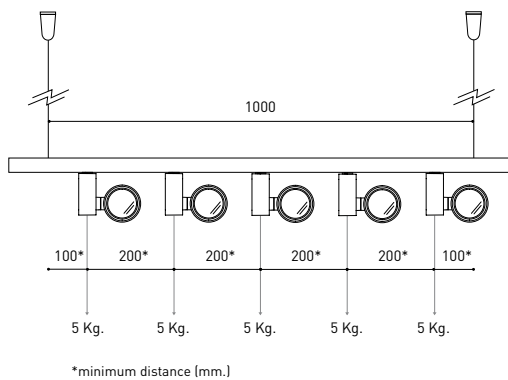

WEIGHT BEAR CAPACITY

Distancia de fijación y capacidad de carga.  
Distancia de fijación recomendada l- 1000mm.

Fastening distance and loading capacity.  
Recommended fastening distance l- 1000mm.

Distance de fixation et capacité de charge.  
Distance de fixation recommandée l- 1000mm.

Distanza di installazione e capacità di carico.  
Distanza consigliata di fissazione l- 1000mm.

Befestigungsabstand und Belastbarkeit.  
Empfohlener Abstand l- 1000mm.

COLOUR | B □ RAL 9016 | N ■ RAL 9005 |

SURFACE & SUSPENDED

FLUSH MOUNTING



POLARITY GROOVE



TRACK 3L Live-End Connector

A219-21-04- | B | N |

A219-21-12- | B | N |



TRACK 3L Central Connector

A219-21-05- | B | N |



TRACK 3L Ceiling Kit

A219-21-06- | B | N |



TRACK 3L Universal Angle

A219-21-07- | B | N |

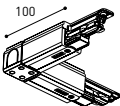

TRACK 3L 90° Angle

A219-21-08- | B | N |

A219-21-13- | B | N |



TRACK 3L T Joint

A219-21-09- | B | N |

A219-21-14- | B | N |



TRACK 3L Mechanical Joint

A219-21-11- | B | N |



TRACK 3L Suspension Kit

A219-21-10- | B | N |

At least 2 units needed

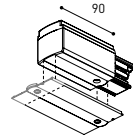

POLARITY GROOVE



TRACK 3L Live-End Connector

A219-21-04- | B | N |

A219-21-12- | B | N |

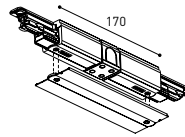

TRACK 3L FLUSH Cover Plate

A219-22-10- | B | N |

Mandatory for installation

TRACK 3L Central Connector

A219-21-05- | B | N |

TRACK 3L FLUSH Cover Plate

A219-22-10- | B | N |

Mandatory for installation



TRACK 3L FLUSH Ceiling Kit

A219-22-06- | B |



TRACK 3L 90° Angle

A219-21-08- | B | N |

A219-21-13- | B | N |

TRACK 3L FLUSH Corner Cover Plate

A219-22-11- | B | N |

Mandatory for installation



TRACK 3L T Joint

A219-21-09- | B | N |

A219-21-14- | B | N |

TRACK 3L FLUSH Corner Cover Plate

A219-22-11- | B | N |

Mandatory for installation

SURFACE & SUSP. / FLUSH MOUNTING



TRACK Contact Joint

A219-20-01- | B | N |



TRACK End

A219-20-02- | B | N |



TRACK Bending Tool

A282-00-00

For tracks its length has been modified

COLOUR | B □ RAL 9016 | N ■ RAL 9005 |