

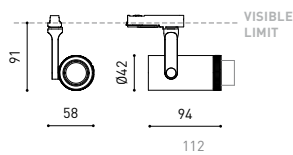

DIMENSIONS



ACCESSORIES



HIGH CHROMATIC LED



TRACK 1L OPTIONS

AWARDS

PREMIO
ADCV 2019
ORO

Name	PLUS MINI 1L 2700K NT
Reference	A3270020NT
Color	Textured black
RAL	9005
Category	TRACKLIGHTS

LIGHTING INFORMATION

Light source	LED
Gross luminous flux	480 Lm
Power	4,5 W
Power values of the system	6,34 W
Colour temperature	2700 K
Colour Rendering Index	CRI>90
Chromatic stability	Mac Adam Step 2
Light beam angle	10°-41°
Lighting efficiency	20-40%
Efficacy	107 Lm/W
Current intensity	500 mA
Driver	Included
Electrical insulation class	⊕
Voltage	220 V/240 V
Frequency	50/60 Hz
Energy efficiency	A
LED lifespan	L80B10 (Tj=85°C) >60.000h

OTHER DATA

Ingress Protection	IP20
Swivel angle	180°
Rotation angle	350°
Track type	Track 1L
Weight	237 g.
Packaged weight	320 g.
Packaging dimensions	199 × 162 × 63 mm.
Units per package	1
Materials	Aluminium / Optical Polymethyl Methacrylate



Plus Mini 1L is a miniaturised spotlight for monophasic track applications which offers the possibility of expanding or concentrating the beam light with just a smooth manual gesture. This characteristic makes Plus the ideal alternative for applications where the precision within the beam of light is essential- like for example: museums, expositions, retail or accent lighting applications.

POLAR DIAGRAM



cd/klm
— C0 - C180 — C90 - C270

CONICAL DIAGRAM

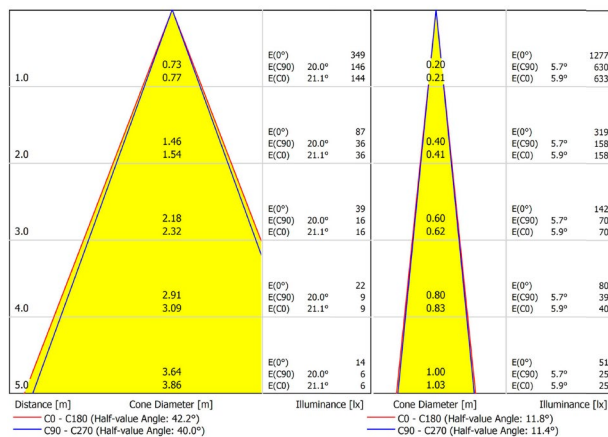

Vivid Model Colour Temperature	2700K	3000K	3500K	4000K	Light Pink
📖 Reading			•	•	
🥗 Fruits & Vegetables		•	•		
🍞 Bakery	•				
👤 Retail		•	•		
💄 Cosmetics			•	•	
🥩 Meat					•
🐟 Fish				•	
🐠 Seafood				•	•



For some of its products, Arkoslight offers the possibility to provide them with a special LED, designed to create an illumination focused on visually promoting goods or products for commercial purposes. It is a high chromaticity LED, capable of identifying the colour shades that produce a positive psychological perception of the illuminated object.

This special LED lighting source offers a much more attractive and intense colour range than a conventional LED, besides being much wider. Technically, this is possible thanks to a special LED setting that includes a «special saturation parameter», capable of highlighting the objects colours and materials in such a way that they seem more attractive within the visible light spectrum. To achieve this performance, in each case, the appropriate diode and specific phosphor coating are carefully selected.

SURFACE & SUSPENDED



TRACK 1L 1m	A264-01-00- B N
TRACK 1L 2m	A264-02-00- B N
TRACK 1L 3m	A264-03-00- B N



POLARITY GROOVE



	TRACK 1L Live-End Connector
	A264-00-01- B N
	A264-00-02- B N

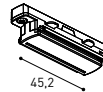

	TRACK 1L Contact Joint
	A264-00-04- B N



	TRACK 1L Central Connector
	A264-00-03- B N



	TRACK 1L End
	A264-00-13- B N

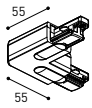

	TRACK 1L 90° Angle
	A264-00-06- B N
	A264-00-07- B N

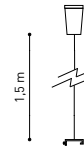

	TRACK 1L Suspension Kit
	A264-00-14- WT NT
At least 2 units needed	



	TRACK 1L Corner connector
	A264-00-15- B N



	TRACK 1L T-Joint
	A264-00-16- B N
	A264-00-17- B N

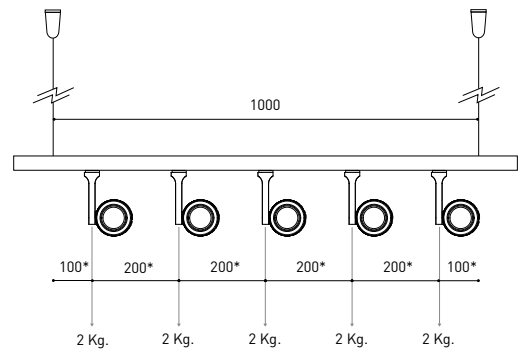

*minimum distance (mm.)

COLOUR | B □ RAL 9016 | N ■ RAL 9005 | WT □ RAL 9016 | NT ■ RAL 9005 |

FLUSH MOUNTING

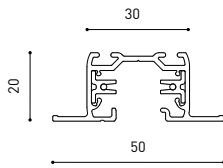

TRACK 1L FLUSH 1m	A264-11-00- B N
TRACK 1L FLUSH 2m	A264-12-00- B N
TRACK 1L FLUSH 3m	A264-13-00- B N



POLARITY GROOVE

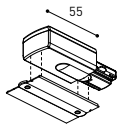

TRACK 1L FLUSH Live-End Connector

A264-00-01- B N
A264-00-02- B N

TRACK 1L FLUSH Cover Plate

A264-10-19- B N

Mandatory for installation

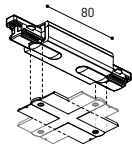

TRACK 1L FLUSH Central Connector

A264-00-03- B N

TRACK 1L FLUSH Corner Cover Plate

A264-10-20- B N

Mandatory for installation

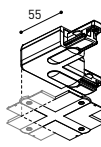

TRACK 1L FLUSH 90° Angle

A264-00-06- B N
A264-00-07- B N

TRACK 1L FLUSH Corner Cover Plate

A264-10-20- B N

Mandatory for installation

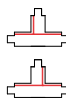
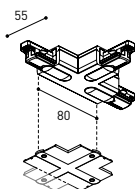

TRACK 1L FLUSH T-Joint

A264-00-16- B N
A264-00-17- B N

TRACK 1L FLUSH Corner Cover Plate

A264-10-20- B N

Mandatory for installation



TRACK 1L Contact Joint

A264-00-04- B N



TRACK 1L End

A264-00-13- B N



TRACK 1L FLUSH Suspension Kit

A264-10-15



*minimum distance [mm.]

COLOUR | B □ RAL 9016 | N ■ RAL 9005 |