



## DIMENSIONS



## ACCESSORIES



HIGH CHROMATIC LED



BEAM MIXER DIFFUSER

ANTI-GLARE HONEYCOMB  
LOUVER

TRACK 48V OPTIONS

## AWARDS



Name	TOP MINI 48V 30° 3000K NT
Reference	A3400121NT
Color	Textured black
RAL	9005
Category	TRACKLIGHTS

## PRODUCT

TOP MINI 48V 30° 3000K NT

A3400121NT

Textured black

9005

TRACKLIGHTS

## LIGHTING INFORMATION

Light source	LED
Gross luminous flux	640 Lm
Power	6,5 W
Power values of the system	6,84 W
Colour temperature	3000 K
Colour Rendering Index	CRI>90
Chromatic stability	Mac Adam Step 2
Light beam angle	30°
Unified Glare Rating	UGR<19
Lighting efficiency	89%
Efficacy	98 Lm/W
Current intensity	700 mA
Control through bluetooth	Please Consult
Driver	Included
Electrical insulation class	III
Voltage	48 Vdc
Energy efficiency	A+
LED lifespan	L80B10 (Tj=85°C) >60.000h

## OTHER DATA

Ingress Protection	IP20
Track type	Track 48V
Weight	95 g.
Packaged weight	165 g.
Packaging dimensions	188 x 163 x 53 mm.
Units per package	1
Materials	Aluminium / Polycarbonate



Top 48V is miniaturized luminary that serves as a downlight low voltage tracklight systems. Its reduced dimensions make Top the perfect candidate for projects where a discrete presence and a perfect integration are needed. It is a pure line and an architectural aesthetic design. Moreover, in terms of lighting performance, Top offers a conical distribution with three possible beam angles (flood, medium and spot).

POLAR DIAGRAM

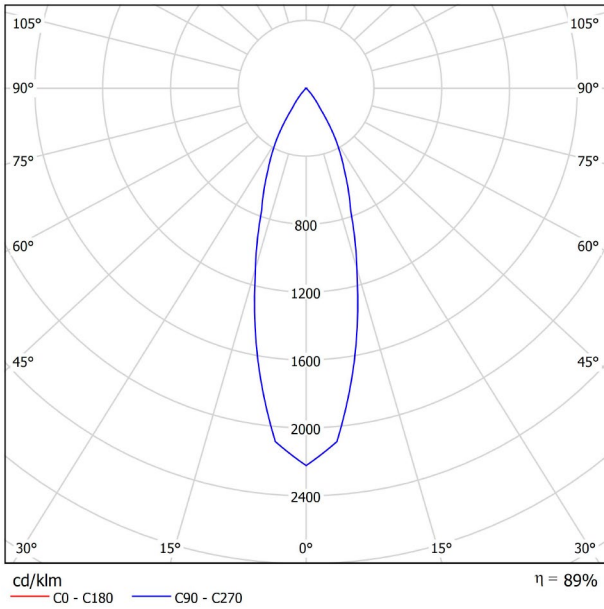

CONICAL DIAGRAM

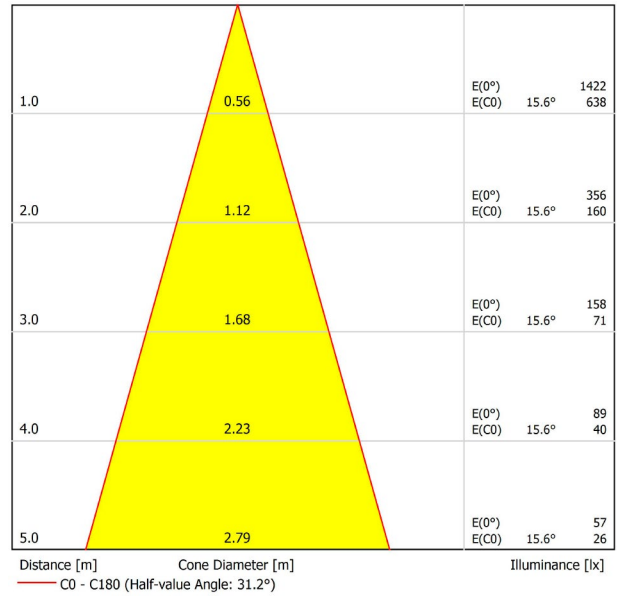

Vivid Model Colour Temperature	2700K	3000K	3500K	4000K	Light Pink
📖 Reading			•	•	
🥬 Fruits & Vegetables		•	•		
🍞 Bakery	•				
👤 Retail		•	•		
💄 Cosmetics			•	•	
🥩 Meat					•
🐟 Fish				•	
🐠 Seafood				•	•



For some of its products, Arkoslight offers the possibility to provide them with a special LED, designed to create an illumination focused on visually promoting goods or products for commercial purposes. It is a high chromaticity LED, capable of identifying the colour shades that produce a positive psychological perception of the illuminated object.

This special LED lighting source offers a much more attractive and intense colour range than a conventional LED, besides being much wider. Technically, this is possible thanks to a special LED setting that includes a «special saturation parameter», capable of highlighting the objects colours and materials in such a way that they seem more attractive within the visible light spectrum. To achieve this performance, in each case, the appropriate diode and specific phosphor coating are carefully selected.



	PRODUCT
Model	Beam Mixer Diffuser
Reference	08050100
Category	Accessories

NOT SOLD SEPARATELY.

The Beam Mixer Diffuser is used to smooth beam artifacts caused by parabolic, Fresnel, or TIR lens collimators without significant broadening.

The unique mixing design provides superior far-field smoothing and color mixing with high on-axis brightness. Compared with traditional diffusers, it maintains higher central beam candlepower (CBCP), and produce less undesirable "field light" at higher angles.



	PRODUCT
Model	Anti-glare Honeycomb Louver
Reference	08070000NT
Colour	NT ■   Textured black
Category	Accessories

NOT SOLD SEPARATELY.



Accessory made up of louver in the shape of a honeycomb panel to reduce glare and the effects of direct rays of vision.

# TRACK 48V TRIMLESS

**ARKOSLIGHT®**

## TRACK 48V SURFACE

Available on request. Please consult.



TRACK 48V 1M	A338-01-00-   N
TRACK 48V 2M	A338-02-00-   N
TRACK 48V 3M	A338-03-00-   N
TRACK 48V Corner 90° One Plane	A338-06-00-   N
TRACK 48V Corner 90° Two Planes	A338-07-00-   N



		P	I	D
CONSTANT VOLTAGE LED POWER SUPPLY	0434-01-21	75W	48V	180 x 52 x 30mm
	0434-01-22	150W	48V	240 x 60 x 49mm
	0434-01-19	75W	48V	235 x 100 x 31mm
	0434-01-20	150W	48V	235 x 100 x 31mm

### CABLE SECTION AND LENGTH BETWEEN TRACK 48V AND POWER SUPPLY

TRACK LENGTH (m)		10			20		29
CABLE LENGTH (m)		1	10	20	1	10	1
POWER (W)	CABLE SECTION (mm²)						
75W	0,75mm²	✓	✓	✓	✓	✓	✓
	1,5mm²	✓	✓	✓	✓	✓	✓
150W	0,75mm²	✓	X	X	✓	X	✓
	1,5mm²	✓	✓	X	✓	✓	✓

COLOUR | N ■ RAL 9005 |

Recommended for installations where the profile can be installed before the false plasteboard ceiling (thickness 12,5mm.)



# TRACK 48V TRIMLESS

**ARKOSLIGHT®**

## TRACK 48V SURFACE

Available on request. Please consult.

### TRACK 48V 90° CORNER One Plane



\*Electrical connection not included

### TRACK 48V 90° CORNER Two Planes

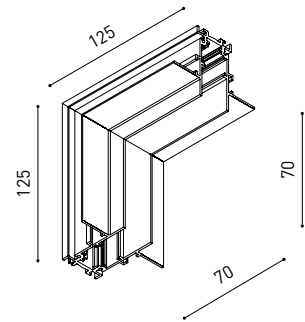

\*Electrical connection not included



#### TRACK 48V Live-End Connector

A338-00-01- | N |



#### TRACK 48V End

A338-00-06- | N |



#### TRACK 48V Central Connector

A338-00-02- | N |



#### TRACK 48V End Feed

A338-00-07- | N |



#### TRACK 48V Corner 90° Connector

A338-00-12



#### TRACK 48V Suspension Kit

A338-00-08

See accessories quantities\*



#### TRACK 48V Short T-Bracket

A338-00-03



#### TRACK 48V Clamp for M6 ROD

A338-00-09

See accessories quantities\*



#### TRACK 48V Long T-Bracket

A338-00-04



#### TRACK 48V Track Clamp

A338-00-10

See accessories quantities\*



#### TRACK 48V Straight Joiners (2 Units)

A338-00-05

#### \* SUGGESTED MOUNTING ACCESSORIES QUANTITIES

1000 mm - 2 Pcs.

2000 mm - 3 Pcs.

3000 mm - 4 Pcs.

COLOUR | N ■ RAL 9005 |

Recommended for installations where the profile can be installed before the false plasteboard ceiling (thickness 12,5mm.)