

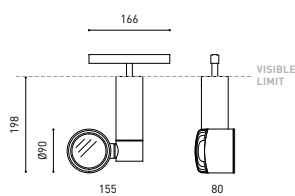

## DIMENSIONS



## ACCESSORIES



HIGH CHROMATIC LED



ANTI-GLARE HONEYCOMB LOUVER



ELLIPTICAL REFRACTOR | BEAM MIXER DIFFUSER



TRACK 48V OPTIONS

## AWARDS



Name	ZEN TUBE 48V 3 16° 2700K NT
Reference	A3411310NT
Color	Textured black
RAL	9005
Category	TRACKLIGHTS

## PRODUCT

Light source	LED
Gross luminous flux	3070 Lm
Power	23 W
Power values of the system	24,21 W
Colour temperature	2700 K
Colour Rendering Index	CRI>90
Chromatic stability	Mac Adam Step 2
Light beam angle	16°
Lighting efficiency	90%
Efficacy	133 Lm/W
Current intensity	700 mA
Control through bluetooth	Please Consult
Driver	Included
Electrical insulation class	III
Voltage	48 Vdc
Energy efficiency	A++
LED lifespan	L80B10 (Tj=85°C) >60.000h

## LIGHTING INFORMATION

Ingress Protection	IP20
Swivel angle	270°
Rotation angle	355°
Track type	Track 48V
Weight	835 g.
Packaged weight	1005 g.
Packaging dimensions	274 × 228 × 98 mm.
Units per package	1
Materials	Aluminium / Glass-Trans

## OTHER DATA



Zen Tube is Arkoslight's most awarded spotlight for its design. A very elegant and attractive product. In its reduced dimensions it encloses an outstanding performance for such a minimalistic piece.

POLAR DIAGRAM

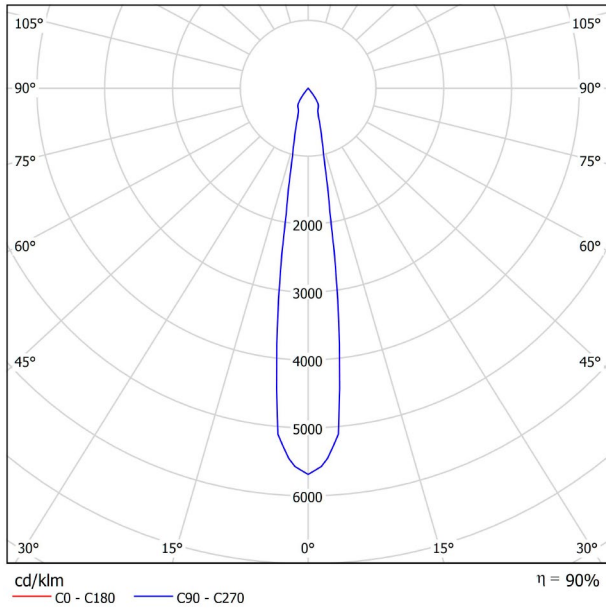

CONICAL DIAGRAM

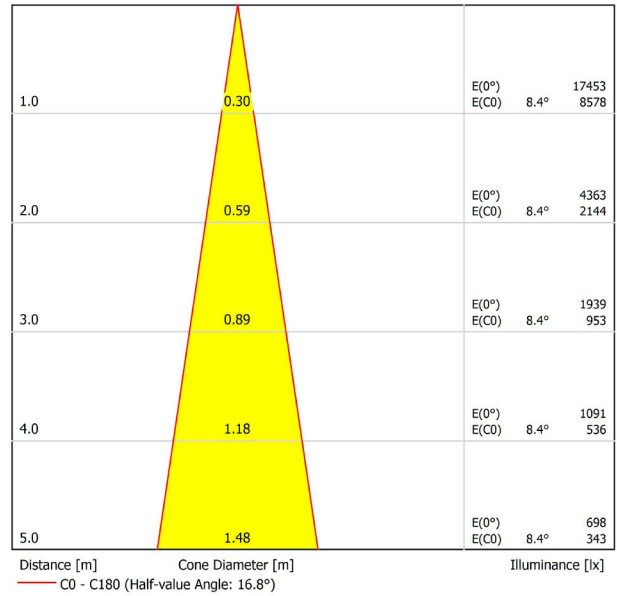

Vivid Model Colour Temperature	2700K	3000K	3500K	4000K	Light Pink
📖 Reading			•	•	
🥬 Fruits & Vegetables		•	•		
🍞 Bakery	•				
👤 Retail		•	•		
💄 Cosmetics			•	•	
🥩 Meat					•
🐟 Fish				•	
🐠 Seafood				•	•



For some of its products, Arkoslight offers the possibility to provide them with a special LED, designed to create an illumination focused on visually promoting goods or products for commercial purposes. It is a high chromaticity LED, capable of identifying the colour shades that produce a positive psychological perception of the illuminated object.

This special LED lighting source offers a much more attractive and intense colour range than a conventional LED, besides being much wider. Technically, this is possible thanks to a special LED setting that includes a «special saturation parameter», capable of highlighting the objects colours and materials in such a way that they seem more attractive within the visible light spectrum. To achieve this performance, in each case, the appropriate diode and specific phosphor coating are carefully selected.

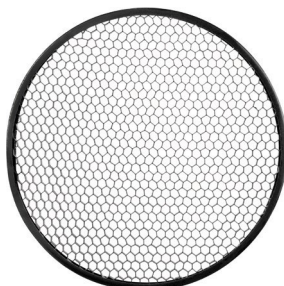

	PRODUCT
Model	Anti-glare Honeycomb Louver
Reference	07020200
Category	Accessories
	NOT SOLD SEPARATELY.



Accessory made up of louver in the shape of a honeycomb panel to reduce glare and the effects of direct rays of vision.



	PRODUCT
Model	Elliptical Refractor
Reference	07000800
Category	Accessories

NOT SOLD SEPARATELY.

Lens that modifies the light beam to achieve an elliptical shape through light refraction in its optical glass.



	PRODUCT
Model	Beam Mixer Diffuser
Reference	08050200
Category	Accessories

NOT SOLD SEPARATELY.

The Beam Mixer Diffuser is used to smooth beam artifacts caused by parabolic, Fresnel, or TIR lens collimators without significant broadening.

The unique mixing design provides superior far-field smoothing and color mixing with high on-axis brightness. Compared with traditional diffusers, it maintains higher central beam candlepower (CBCP), and produce less undesirable "field light" at higher angles.

# TRACK 48V TRIMLESS

**ARKOSLIGHT®**

## TRACK 48V SURFACE

Available on request. Please consult.



TRACK 48V 1M	A338-01-00-   N
TRACK 48V 2M	A338-02-00-   N
TRACK 48V 3M	A338-03-00-   N
TRACK 48V Corner 90° One Plane	A338-06-00-   N
TRACK 48V Corner 90° Two Planes	A338-07-00-   N



		P	I	D
CONSTANT VOLTAGE LED POWER SUPPLY	0434-01-21	75W	48V	180 x 52 x 30mm
	0434-01-22	150W	48V	240 x 60 x 49mm
	0434-01-19	75W	48V	235 x 100 x 31mm
	0434-01-20	150W	48V	235 x 100 x 31mm

### CABLE SECTION AND LENGTH BETWEEN TRACK 48V AND POWER SUPPLY

TRACK LENGTH (m)		10			20		29
CABLE LENGTH (m)		1	10	20	1	10	1
POWER (W)	CABLE SECTION (mm²)						
75W	0,75mm²	✓	✓	✓	✓	✓	✓
	1,5mm²	✓	✓	✓	✓	✓	✓
150W	0,75mm²	✓	X	X	✓	X	✓
	1,5mm²	✓	✓	X	✓	✓	✓

COLOUR | N ■ RAL 9005 |

Recommended for installations where the profile can be installed before the false plasteboard ceiling (thickness 12,5mm.)



# TRACK 48V TRIMLESS

**ARKOSLIGHT®**

## TRACK 48V SURFACE

Available on request. Please consult.

### TRACK 48V 90° CORNER One Plane

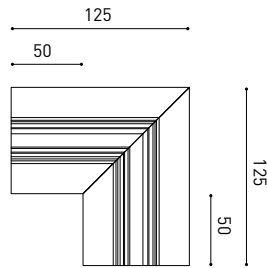

\*Electrical connection not included

### TRACK 48V 90° CORNER Two Planes

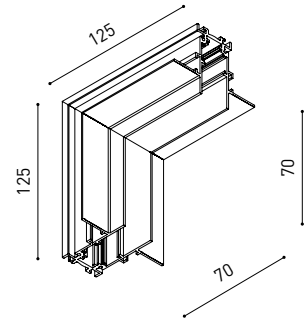

\*Electrical connection not included



#### TRACK 48V Live-End Connector

A338-00-01- | N |



#### TRACK 48V End

A338-00-06- | N |

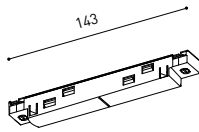

#### TRACK 48V Central Connector

A338-00-02- | N |



#### TRACK 48V End Feed

A338-00-07- | N |



#### TRACK 48V Corner 90° Connector

A338-00-12

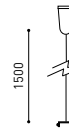

#### TRACK 48V Suspension Kit

A338-00-08

See accessories quantities\*



#### TRACK 48V Short T-Bracket

A338-00-03



#### TRACK 48V Clamp for M6 ROD

A338-00-09

See accessories quantities\*



#### TRACK 48V Long T-Bracket

A338-00-04



#### TRACK 48V Track Clamp

A338-00-10

See accessories quantities\*

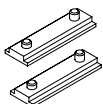

#### TRACK 48V Straight Joiners (2 Units)

A338-00-05

#### \* SUGGESTED MOUNTING ACCESSORIES QUANTITIES

1000 mm - 2 Pcs.  
2000 mm - 3 Pcs.  
3000 mm - 4 Pcs.

COLOUR | N ■ RAL 9005 |

Recommended for installations where the profile can be installed before the false plasteboard ceiling (thickness 12,5mm.)

Calle N · Pol. Ind. EL OLIVAL  
46394 Ribarroja del Turia · Valencia (Spain)  
Tel. +34 961 667 207 · Fax +34 961 667 054  
info@arkoslight.com · www.arkoslight.com

