

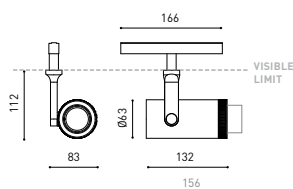

DIMENSIONES



ACCESORIOS



HIGH CHROMATIC LED



TRACK 48V OPTIONS

PREMIOS

PREMIO
ADCV 2019
ORO

Nombre	PLUS 48V 4000K NT
Referencia	A3230012NT
Color	Negro Texturado
RAL	9005
Categoría	TRACKLIGHTS

PRODUCTO

Fuente de Luz	LED
Flujo Lumínico	2030 Lm
Potencia	18 W
Potencia del sistema	18,95 W
Temperatura de color	4000 K
Índice de reproducción cromática	CRI>90
Estabilidad cromática	Mac Adam Step 2
Ángulo del haz de luz	12°-51°
Eficiencia lumínica	26-40%
Eficacia	113 Lm/W
Intensidad de corriente	500 mA
Control por bluetooth	Consultar
Driver	Incluido
Clase de Seguridad Eléctrica	III
Tensión	48 Vdc
Eficiencia Energética	A
Horas de Vida del LED	L80B10 (Tj=85°C) >60.000h

INFORMACIÓN LUMÍNICA

OTROS DATOS

Estanqueidad	IP20
Ángulo de basculación	180°
Ángulo de giro	360°
Tipo de carril	Track 48V
Peso	583 g.
Peso con embalaje	705 g.
Dimensiones embalaje	225 × 191 × 84 mm.
Unidades por embalaje	1
Materiales	Aluminio / Cristal Optico



Plus 48V es un proyector destinado a aplicación en carril de bajo voltaje que ofrece la capacidad de ampliar o concentrar la apertura del haz de luz con un suave movimiento manual. Esta característica hace a Plus el proyector ideal para aplicaciones donde la precisión del haz de luz es un elemento esencial, tales como museos, exposiciones, retail o aplicaciones de acento.

DIAGRAMA POLAR

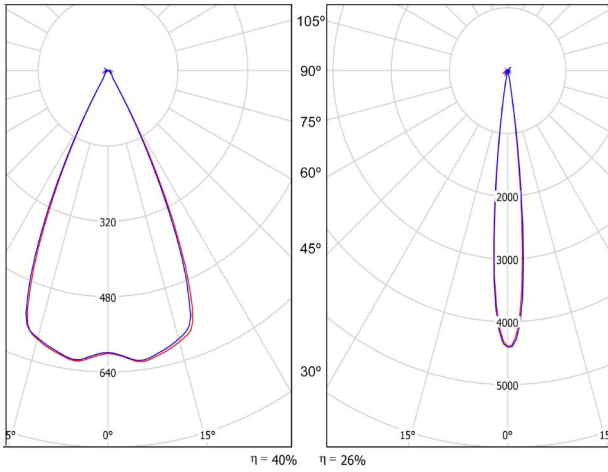

cd/klm

— C0 - C180 — C90 - C270

DIAGRAMA CÓNICO

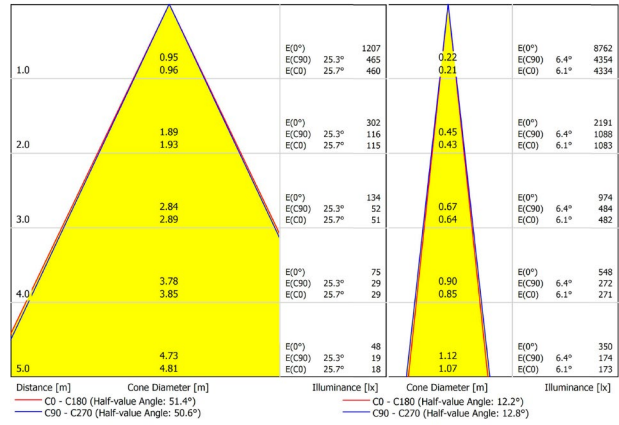

PARA PRESENTACIÓN COMERCIAL DE PRODUCTO

Vivid Model Colour Temperature	2700K	3000K	3500K	4000K	Light Pink
📖 Reading			•	•	
🥗 Fruits & Vegetables		•	•		
🍞 Bakery	•				
👤 Retail		•	•		
💄 Cosmetics			•	•	
🥩 Meat					•
🐟 Fish				•	
🐠 Seafood				•	•



Arkosligh ofrece en algunos de sus productos la posibilidad de dotarlos de un LED especial para iluminación orientada a la promoción visual de bienes y productos con finalidad comercial.

Se trata de un LED de alta cromaticidad que persigue destacar los tonos que favorecen la percepción psicológica positiva del objeto iluminado.

Esta fuente de luz LED especial ofrece una paleta de colores más atractiva e intensa, por encima de lo que lo hace un LED convencional. Esto se consigue gracias a la configuración del LED bajo un "parámetro especial de saturación" que consigue que los colores y la textura de los objetos se muestren más atractivos dentro del espectro de luz visible. Para ello se selecciona, en cada caso, el diodo pertinente y su fósforo de recubrimiento específico.

TRACK 48V TRIMLESS

ARKOSLIGHT®

TRACK 48V SURFACE

Available on request. Please consult.

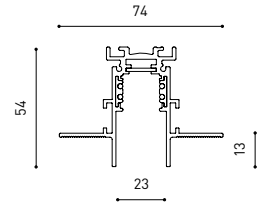

TRACK 48V 1M	A338-01-00- N
TRACK 48V 2M	A338-02-00- N
TRACK 48V 3M	A338-03-00- N
TRACK 48V Corner 90° One Plane	A338-06-00- N
TRACK 48V Corner 90° Two Planes	A338-07-00- N

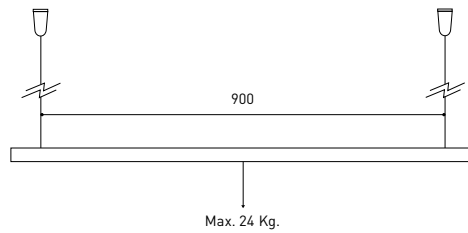

		P	I	D
CONSTANT VOLTAGE LED POWER SUPPLY	0434-01-21	75W	48V	180 x 52 x 30mm
	0434-01-22	150W	48V	240 x 60 x 49mm
	0434-01-19	75W	48V	235 x 100 x 31mm
	0434-01-20	150W	48V	235 x 100 x 31mm

CABLE SECTION AND LENGTH BETWEEN TRACK 48V AND POWER SUPPLY

TRACK LENGTH (m)		10			20		29
CABLE LENGTH (m)		1	10	20	1	10	1
POWER (W)	CABLE SECTION (mm²)						
75W	0,75mm²	✓	✓	✓	✓	✓	✓
	1,5mm²	✓	✓	✓	✓	✓	✓
150W	0,75mm²	✓	X	X	✓	X	✓
	1,5mm²	✓	✓	X	✓	✓	✓

COLOUR | N ■ RAL 9005 |

Recommended for installations where the profile can be installed before the false plasteboard ceiling (thickness 12,5mm.)



TRACK 48V TRIMLESS

ARKOSLIGHT®

TRACK 48V SURFACE

Available on request. Please consult.

TRACK 48V 90° CORNER One Plane

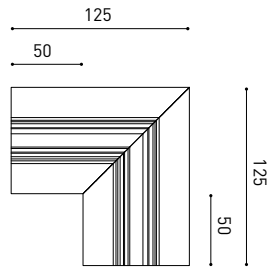

*Electrical connection not included

TRACK 48V 90° CORNER Two Planes

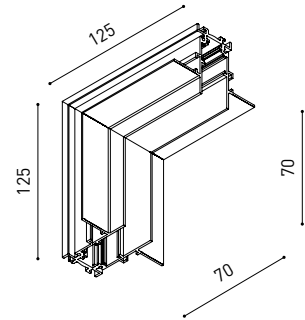

*Electrical connection not included

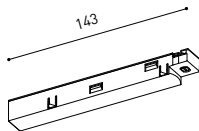

TRACK 48V Live-End Connector

A338-00-01- | N |



TRACK 48V End

A338-00-06- | N |

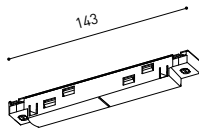

TRACK 48V Central Connector

A338-00-02- | N |



TRACK 48V End Feed

A338-00-07- | N |

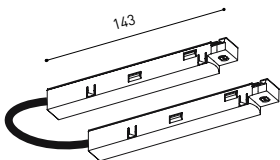

TRACK 48V Corner 90° Connector

A338-00-12

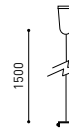

TRACK 48V Suspension Kit

A338-00-08

See accessories quantities*



TRACK 48V Short T-Bracket

A338-00-03



TRACK 48V Clamp for M6 ROD

A338-00-09

See accessories quantities*

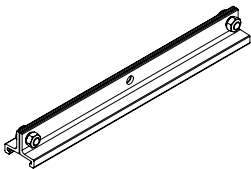

TRACK 48V Long T-Bracket

A338-00-04



TRACK 48V Track Clamp

A338-00-10

See accessories quantities*

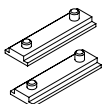

TRACK 48V Straight Joiners (2 Units)

A338-00-05

* SUGGESTED MOUNTING ACCESSORIES QUANTITIES

1000 mm - 2 Pcs.
2000 mm - 3 Pcs.
3000 mm - 4 Pcs.

COLOUR | N ■ RAL 9005 |

Recommended for installations where the profile can be installed before the false plasteboard ceiling (thickness 12,5mm.)