

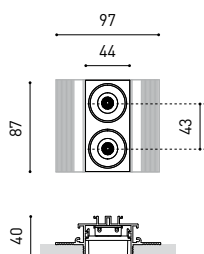

## GRÖÖE



## ZUBEHÖR



CUSTOM & MOUNTING  
ACCESSORIES (MANDATORY)



DRIVER OPTIONS (MANDATORY)

## PREISE



Name	BLACK FOSTER 2 3000K N
Artikelnummer	A3172001N
Farbe	Schwarz matt
RAL	9005
Kategorie	CUSTOM SYSTEMS

## PRODUKT

Lichtquelle	LED
Bruttolichtstrom	420 Lm
Leistung	4,2 W
Leistungswerte des Systems	5,52 W
Farbtemperatur	3000 K
Farbwiedergabeindex	CRI>90
Farbstabilität	Mac Adam Step 3
Abstrahlwinkel	38°
Blendungsbewertung	UGR<19
Leuchtenwirkungsgrad (LOR)	90%
Lichtausbeute	100 Lm/W
Stromstärke	700 mA
Helligkeitssteuerung	Bitte anfragen
Steuerung über Bluetooth	Bitte anfragen
Vorschaltgerät	Exklusiv
Notstromaggregat	Bitte anfragen
Schutzklasse	III
Spannung	220 V/240 V
Frequenz	50/60 Hz
Energieeffizienzklasse	A+
Nutzlebensdauer der LED in Betriebsstunden	L80B10 (Tc=85°C) >60.000h

## LICHTINFORMATIONEN

## ANDERE DATEN

Dichtigkeit	IP20
Gewicht	180 g.
Gewicht inkl. Verpackung	275 g.
Abmessungen der Verpackung	212 x 155 x 73 mm.
Stück pro Verpackung	1
Materialien	Aluminium / Acrylnitril-Butadien-Styrol / Polycarbonat



Black Foster ist ein individuell gestaltbares Leuchtensystem welches den „Invisible Black Effect“ der Shotlight Serie auf ein lineares Profilsystem projiziert. Black Foster besteht aus einer Reihe von kombinierbaren Modulen und ermöglicht den Wechsel von Segmenten mit und ohne Lichtaustritt. Egal, ob es ein-/ oder ausgeschaltet ist, diese Leuchte behält immer die Ästhetik einer perfekten dunklen Linie. Für den Betrachter ist es unmöglich, zwischen den beleuchteten und unbeleuchteten Segmenten zu unterscheiden. \*\*\* NOTE: Nur auf Flächen aus Gipskarton mit 12,5 mm Stärke installierbar.

POLAR-KOORDINATEN DIAGRAMM

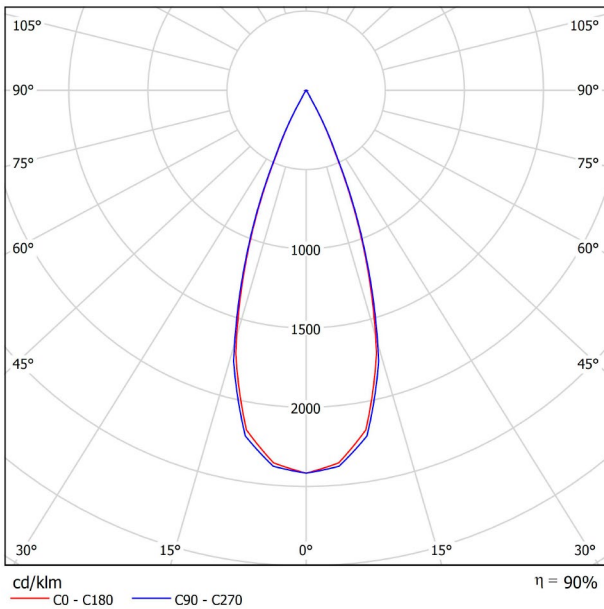

KEGELDIAGRAMM

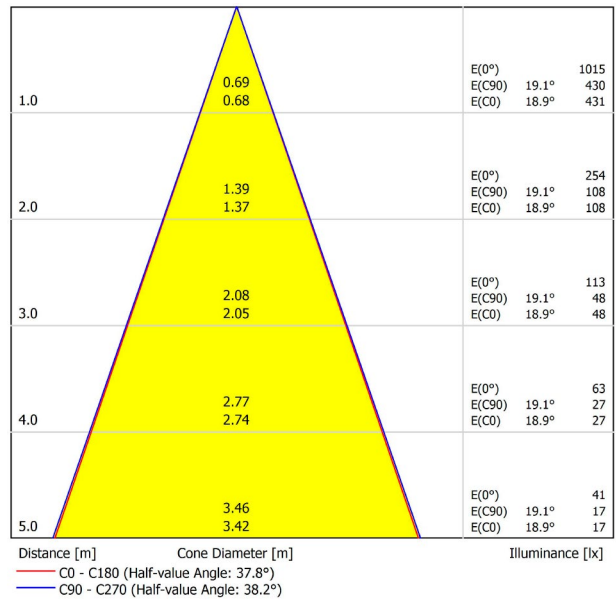

UGR

Glare Evaluation According to UGR												
ρ Ceiling		70	70	50	50	30	70	70	50	50	30	
ρ Walls		50	30	50	30	30	50	30	50	30	30	
ρ Floor		20	20	20	20	20	20	20	20	20	20	
Room Size X Y		Viewing direction at right angles to lamp axis					Viewing direction parallel to lamp axis					
2H	2H	-10.5	-9.9	-10.3	-9.7	-9.5	-10.1	-9.5	-9.9	-9.3	-9.1	
	3H	-5.5	-4.9	-5.2	-4.7	-4.4	-5.2	-4.6	-4.9	-4.4	-4.2	
	4H	-2.6	-2.0	-2.3	-1.8	-1.5	-2.1	-1.6	-1.8	-1.3	-1.1	
	6H	0.9	1.4	1.2	1.7	2.0	1.2	1.7	1.5	2.0	2.2	
	8H	2.8	3.3	3.1	3.6	3.8	2.9	3.4	3.3	3.7	4.0	
4H	12H	4.8	5.2	5.1	5.5	5.9	4.9	5.4	5.2	5.7	6.0	
	2H	-8.9	-8.3	-8.6	-8.1	-7.8	-8.6	-8.1	-8.3	-7.8	-7.6	
	3H	-3.7	-3.2	-3.3	-2.9	-2.6	-3.5	-3.0	-3.1	-2.7	-2.4	
	4H	-0.7	-0.3	-0.3	0.1	0.4	-0.3	0.1	0.1	0.4	0.8	
	6H	2.9	3.2	3.3	3.5	3.9	3.0	3.4	3.4	3.7	4.1	
8H	8H	4.8	5.0	5.2	5.4	5.8	4.9	5.2	5.3	5.5	5.9	
	12H	6.8	7.1	7.3	7.5	7.9	6.9	7.2	7.4	7.6	8.0	
	4H	0.7	1.0	1.1	1.4	1.8	0.9	1.2	1.3	1.6	2.0	
	6H	4.3	4.5	4.8	5.0	5.4	4.5	4.7	4.9	5.1	5.5	
	8H	6.3	6.5	6.8	7.0	7.4	6.4	6.6	6.9	7.0	7.5	
12H	12H	8.6	8.7	9.0	9.2	9.7	8.6	8.8	9.1	9.2	9.7	
	4H	1.2	1.4	1.6	1.8	2.2	1.4	1.6	1.8	2.0	2.4	
	6H	4.9	5.0	5.3	5.5	6.0	5.0	5.1	5.4	5.6	6.1	
8H	7.0	7.1	7.5	7.6	8.1	7.0	7.2	7.5	7.6	8.1		
Variation of the observer position for the luminaire distances S												
S = 1.0H		+0.5 / -0.3					+0.6 / -0.3					
S = 1.5H		+1.1 / -0.5					+1.3 / -0.5					
S = 2.0H		+1.9 / -0.8					+2.3 / -0.8					
Standard table		---					---					
Correction Summand		---					---					
Corrected Glare Indices referring to 420lm Total Luminous Flux												

L

<b>BLACK FOSTER Custom</b>	<b>Gap Corner 90°</b>	<b>A317-00-07-   N  </b>	200 x 200mm
	<b>Gap 250</b>	<b>A317-00-01-   N  </b>	250mm
	<b>Gap 500</b>	<b>A317-00-02-   N  </b>	500mm
	<b>Gap 1000</b>	<b>A317-00-03-   N  </b>	1000mm
	<b>Gap 2000</b>	<b>A317-00-04-   N  </b>	2000mm

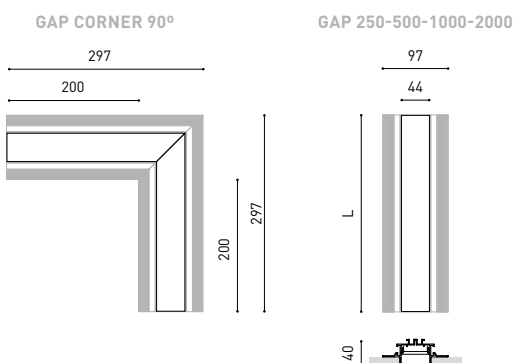

<b>BLACK FOSTER End Caps Kit</b>	<b>A317-00-05-   N  </b>	Thickness of each cover 2mm.
----------------------------------	--------------------------	------------------------------



<b>BLACK FOSTER Straight Joiner</b>	<b>A317-00-06</b>	
-------------------------------------	-------------------	--

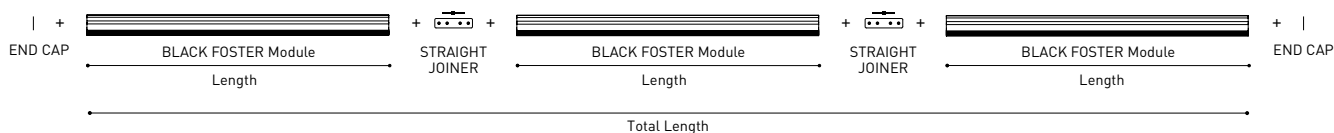

COLOUR | **N ■ RAL 9005** | MATERIAL | AL | ABS+PC |

**BLACK FOSTER Track Clamp Kit**

A219-21-20- | B |



**BLACK FOSTER Flush Ceiling Kit**

A219-22-06- | B |



**BLACK FOSTER Track Clamp Kit for M6 ROD**

A219-21-21- | B |



**BLACK FOSTER Suspension Kit**

A219-21-10- | B |

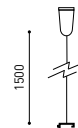

**SUGGESTED MOUNTING ACCESSORIES QUANTITIES**

Black Foster custom 2, 3, 5: 1Pcs.

Black Foster custom 10, 15: 2Pcs.



Gap 250, 500, 1000: 2Pcs.

Gap 2000: 4Pcs.

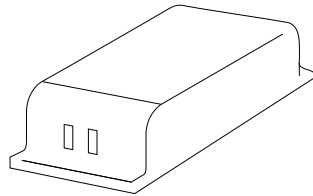
COLOUR | B □ |



#### DRIVER OPTIONS\*

		P	I	D
 NO DIM	<b>0434-01-18</b>	50W	700mA	124 x 79 x 22mm
 DALI   Push / 1-10V	<b>0433-00-23</b>	50W	700mA	124 x 79 x 22mm

Connect in series only in order to keep a constant current.