

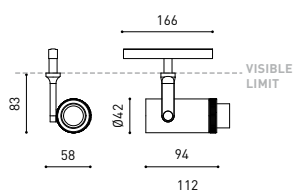

DIMENSIONI



ACCESSORI



HIGH CHROMATIC LED



TRACK 48V OPTIONS

PRODOTTO

Nome	PLUS MINI 48V DIM DALI 2700K WT
Articolo	A3260020WT
Colore	Bianco Strutturato
Potere del sistema	9016
Categoria	TRACKLIGHTS

INFORMAZIONI LUCE

Sorgente di luce	LED
Flusso luminoso lordo	630 Lm
Potenza	6,5 W
Valori di potenza del sistema	7,22 W
Temperatura di colore	2700 K
Indice di Riproduzione Cromatica	CRI>90
Stabilità cromatica	Mac Adam Step 2
Angolo del fascio di luce	10°-41°
Efficienza luminosa	20-40%
Efficienza	97 Lm/W
Intensità di corrente	700 mA
Regolazione	DALI
Controllo con bluetooth	Consultare
Driver	Incluso
Classe di isolamento elettrico	III
Tensione	48 V
Frequenza	0 Hz
Efficienza energetica	A
Ore di vita del LED	L80B10 (Tj=85°C) >60.000h

ALTRI DATI

Tenuta stagna	IP20
Angolo di oscillazione	180°
Angolo di rotazione	360°
Tipo di binario	Track 48V
Peso	242 g.
Peso compresso l'imballaggio	325 g.
Dimensioni dell'imballaggio	199 x 162 x 63 mm.
Unità per imballaggio	1
Materiali	Alluminio / Vetro Ottico



Plus 48V è un proiettore destinato all'applicazione su binari di basso voltaggio capace di ampliare o concentrare l'apertura della sorgente di luce con un leggero intervento manuale. Questa caratteristica rende il Plus il proiettore ideale per applicazioni di precisione, come musei, esposizioni, retail e applicazioni che necessitano di particolare enfasi.

DIAGRAMMA DI ABBAGLIAMENTO POLARE

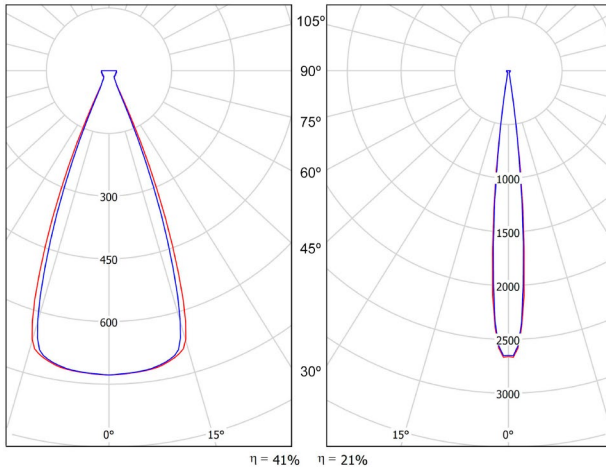

cd/klm
 — C0 - C180 — C90 - C270

DIAGRAMMA CONICO

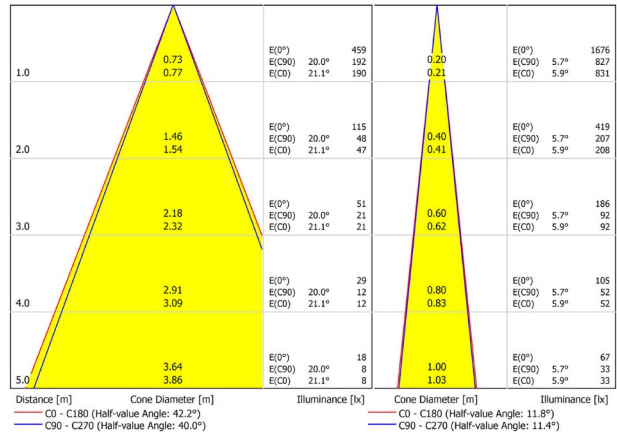

PER PRESENTAZIONE COMMERCIALE DEL PRODOTTO

Vivid Model Colour Temperature	2700K	3000K	3500K	4000K	Light Pink
📖 Reading			•	•	
🥗 Fruits & Vegetables		•	•		
🍞 Bakery	•				
👤 Retail		•	•		
💄 Cosmetics			•	•	
🥩 Meat					•
🐟 Fish				•	
🐠 Seafood				•	•



Arkosligh offre su alcuni dei suoi prodotti la possibilità di dotarli di un LED speciale per illuminazione orientata alla promozione visiva di beni e prodotti a scopo commerciale.

Si tratta di un LED ad alta cromaticità che mette in rilievo le tonalità che favoriscono la percezione psicologica positiva dell'oggetto illuminato.

Questa sorgente di luce LED speciale offre una gamma di colori più attraenti e intensi, superiore a quella che può offrire un LED convenzionale. Ciò si ottiene grazie alla configurazione del LED secondo un "parametro speciale di saturazione" che fa in modo che i colori e la texture degli oggetti appaiano più attraenti all'interno dello spettro di luce visibile. A tale scopo si seleziona, in ciascun caso, l'apposito diodo e il suo fosforo di rivestimento specifico.

TRACK 48V TRIMLESS

ARKOSLIGHT®

TRACK 48V SURFACE

Available on request. Please consult.

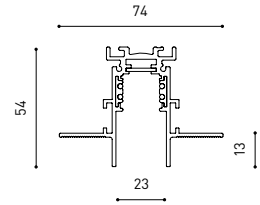

TRACK 48V 1M	A338-01-00- N
TRACK 48V 2M	A338-02-00- N
TRACK 48V 3M	A338-03-00- N
TRACK 48V Corner 90° One Plane	A338-04-00- N
TRACK 48V Corner 90° Two Planes	A338-05-00- N

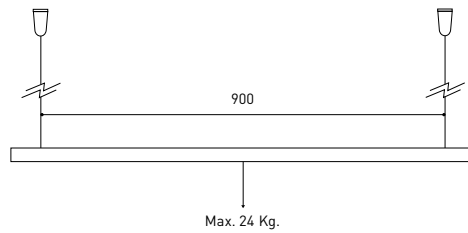

		P	I	D
CONSTANT VOLTAGE LED POWER SUPPLY	0434-01-21	75W	48V	180 x 52 x 30mm
	0434-01-22	150W	48V	240 x 60 x 49mm
	0434-01-19	75W	48V	235 x 100 x 31mm
	0434-01-20	150W	48V	235 x 100 x 31mm

CABLE SECTION AND LENGTH BETWEEN TRACK 48V AND POWER SUPPLY

TRACK LENGTH (m)		10			20		29
CABLE LENGTH (m)		1	10	20	1	10	1
POWER (W)	CABLE SECTION (mm²)						
75W	0,75mm²	✓	✓	✓	✓	✓	✓
	1,5mm²	✓	✓	✓	✓	✓	✓
150W	0,75mm²	✓	X	X	✓	X	✓
	1,5mm²	✓	✓	X	✓	✓	✓

COLOUR | N ■ RAL 9005 |

Recommended for installations where the profile can be installed before the false plasteboard ceiling (thickness 12,5mm.)



TRACK 48V TRIMLESS

ARKOSLIGHT®

TRACK 48V SURFACE

Available on request. Please consult.

TRACK 48V 90° CORNER One Plane

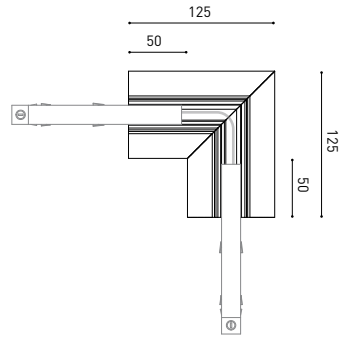

*Electrical connection included

TRACK 48V 90° CORNER Two Planes

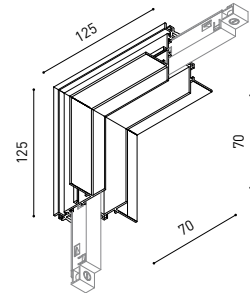

*Electrical connection included

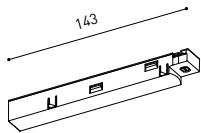

TRACK 48V Live-End Connector

A338-00-01- | N |



TRACK 48V End

A338-00-06- | N |

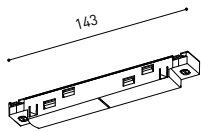

TRACK 48V Central Connector

A338-00-02- | N |



TRACK 48V End Feed

A338-00-07- | N |



TRACK 48V Short T-Bracket

A338-00-03

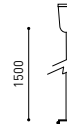

TRACK 48V Suspension Kit

A338-00-08

See accessories quantities*

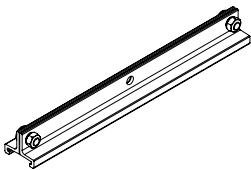

TRACK 48V Long T-Bracket

A338-00-04



TRACK 48V Clamp for M6 ROD

A338-00-09

See accessories quantities*

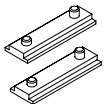

TRACK 48V Straight Joiners (2 Units)

A338-00-05



TRACK 48V Track Clamp

A338-00-10

See accessories quantities*

*** SUGGESTED MOUNTING ACCESSORIES QUANTITIES**

1000 mm - 2 Pcs.
2000 mm - 3 Pcs.
3000 mm - 4 Pcs.

COLOUR | N ■ RAL 9005 |

Recommended for installations where the profile can be installed before the false plasteboard ceiling (thickness 12,5mm.)