

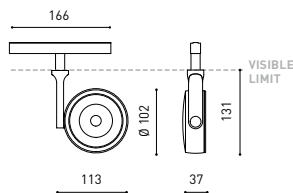

## DIMENSIONS



## ACCESSORIES



HIGH CHROMATIC LED



TRACK 48V OPTIONS

## AWARDS



Name	SIX L 48V 17° 3000K WT
Reference	A3290111WT
Color	Textured white
Power of the system	9016
Category	TRACKLIGHTS
<b>LIGHTING INFORMATION</b>	
Light source	LED
Gross luminous flux	2950 Lm
Power	24,5 W
Power values of the system	26,34 W
Colour temperature	3000 K
Colour Rendering Index	CRI>90
Chromatic stability	Mac Adam Step 2
Light beam angle	17°
Lighting efficiency	93%
Efficacy	120 Lm/W
Current intensity	700 mA
Control through bluetooth	Please Consult
Driver	Included
Electrical insulation class	III
Voltage	48 V
Frequency	0 Hz
Energy efficiency	A+
LED lifespan	L80B10 (Tj=85°C) >60.000h
<b>OTHER DATA</b>	
Ingress Protection	IP20
Swivel angle	310°
Rotation angle	360°
Track type	Track 48V
Weight	555 g.
Packaged weight	660 g.
Packaging dimensions	218 x 195 x 62 mm.
Units per package	1
Materials	Aluminium / Polycarbonate



Six 48V is a family of spotlights for low voltage tracklight applications that stands out for its lightness and elegance. Available in L, M, S, XS and XS Double, its body; disk looking, rounded shaped, encloses an innovative combination of reflector and lens. The combined action of both, allows Six to direct light rays with the maximum uniformity in a very small distance that, at the same time, has made possible its differential design-reduced and minimalist-. In addition, Six can be freely articulated due to its airy arm which allows the spotlight to be orientated in any direction.

POLAR DIAGRAM

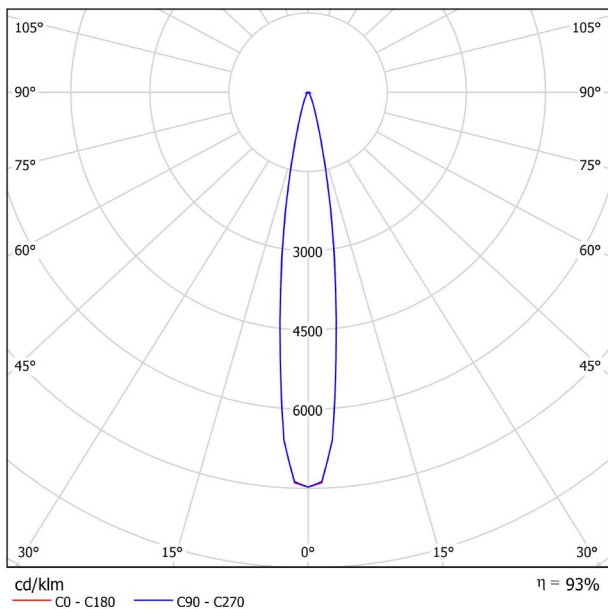

CONICAL DIAGRAM

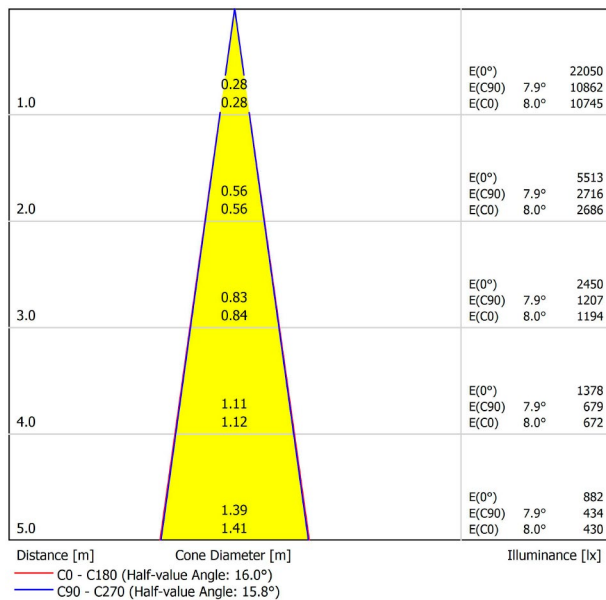

Vivid Model Colour Temperature	2700K	3000K	3500K	4000K	Light Pink
📖 Reading			•	•	
🥗 Fruits & Vegetables		•	•		
🍞 Bakery	•				
👤 Retail		•	•		
💄 Cosmetics			•	•	
🥩 Meat					•
🐟 Fish				•	
🐠 Seafood				•	•



For some of its products, Arkoslight offers the possibility to provide them with a special LED, designed to create an illumination focused on visually promoting goods or products for commercial purposes. It is a high chromaticity LED, capable of identifying the colour shades that produce a positive psychological perception of the illuminated object.

This special LED lighting source offers a much more attractive and intense colour range than a conventional LED, besides being much wider. Technically, this is possible thanks to a special LED setting that includes a «special saturation parameter», capable of highlighting the objects colours and materials in such a way that they seem more attractive within the visible light spectrum. To achieve this performance, in each case, the appropriate diode and specific phosphor coating are carefully selected.

# TRACK 48V TRIMLESS

**ARKOSLIGHT®**

## TRACK 48V SURFACE

Available on request. Please consult.

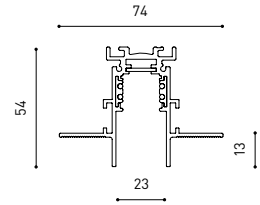

TRACK 48V 1M	A338-01-00-   N
TRACK 48V 2M	A338-02-00-   N
TRACK 48V 3M	A338-03-00-   N
TRACK 48V Corner 90° One Plane	A338-04-00-   N
TRACK 48V Corner 90° Two Planes	A338-05-00-   N

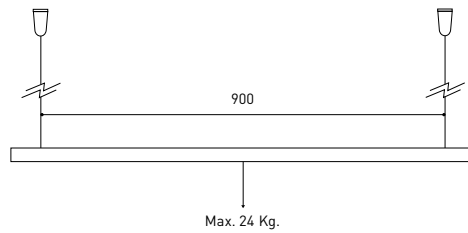

		P	I	D
CONSTANT VOLTAGE LED POWER SUPPLY	0434-01-21	75W	48V	180 x 52 x 30mm
	0434-01-22	150W	48V	240 x 60 x 49mm
	0434-01-19	75W	48V	235 x 100 x 31mm
	0434-01-20	150W	48V	235 x 100 x 31mm

### CABLE SECTION AND LENGTH BETWEEN TRACK 48V AND POWER SUPPLY

TRACK LENGTH (m)		10			20		29
CABLE LENGTH (m)		1	10	20	1	10	1
POWER (W)	CABLE SECTION (mm²)						
75W	0,75mm²	✓	✓	✓	✓	✓	✓
	1,5mm²	✓	✓	✓	✓	✓	✓
150W	0,75mm²	✓	X	X	✓	X	✓
	1,5mm²	✓	✓	X	✓	✓	✓

COLOUR | N ■ RAL 9005 |

Recommended for installations where the profile can be installed before the false plasteboard ceiling (thickness 12,5mm.)



# TRACK 48V TRIMLESS

**ARKOSLIGHT®**

## TRACK 48V SURFACE

Available on request. Please consult.

**TRACK 48V 90° CORNER One Plane**

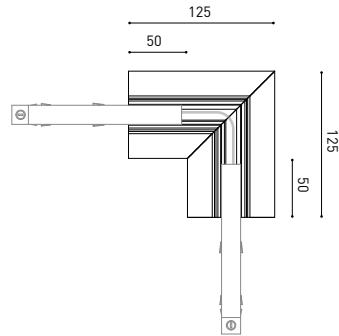

\*Electrical connection included

**TRACK 48V 90° CORNER Two Planes**

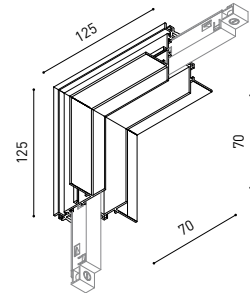

\*Electrical connection included

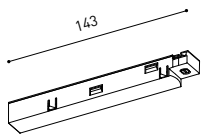

**TRACK 48V Live-End Connector**

A338-00-01- | N |



**TRACK 48V End**

A338-00-06- | N |

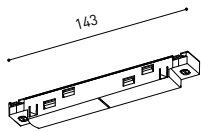

**TRACK 48V Central Connector**

A338-00-02- | N |



**TRACK 48V End Feed**

A338-00-07- | N |



**TRACK 48V Short T-Bracket**

A338-00-03

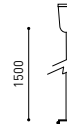

**TRACK 48V Suspension Kit**

A338-00-08

See accessories quantities\*

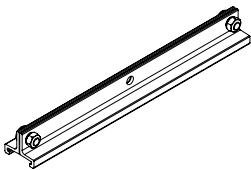

**TRACK 48V Long T-Bracket**

A338-00-04



**TRACK 48V Clamp for M6 ROD**

A338-00-09

See accessories quantities\*

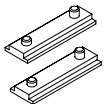

**TRACK 48V Straight Joiners (2 Units)**

A338-00-05



**TRACK 48V Track Clamp**

A338-00-10

See accessories quantities\*

**\* SUGGESTED MOUNTING ACCESSORIES QUANTITIES**

- 1000 mm - 2 Pcs.
- 2000 mm - 3 Pcs.
- 3000 mm - 4 Pcs.

COLOUR | N ■ RAL 9005 |

Recommended for installations where the profile can be installed before the false plasteboard ceiling (thickness 12,5mm.)

