

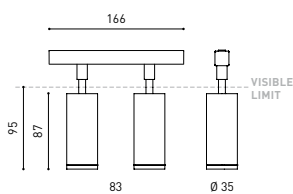

## DIMENSIONS



## ACCESSORIES



ANTI-GLARE HONEYCOMB LOUVER



TRACK 48V OPTIONS

Name	FIT 35 48V DOUBLE 38° 3000K WT
Reference	A3451131WT
Color	Textured white
Power of the system	9016
Category	TRACKLIGHTS
<b>LIGHTING INFORMATION</b>	
Light source	LED
Gross luminous flux	2 x 630 Lm
Power	11 W
Power values of the system	11,83 W
Colour temperature	3000 K
Colour Rendering Index	CRI>90
Chromatic stability	Mac Adam Step 2
Light beam angle	38°
Lighting efficiency	80%
Efficacy	115 Lm/W
Current intensity	500 mA
Control through bluetooth	Please Consult
Driver	Included
Electrical insulation class	III
Voltage	48 V
Frequency	0 Hz
Energy efficiency	A+
LED lifespan	L80B10 (Tj=85°C) >60.000h
<b>OTHER DATA</b>	
Ingress Protection	IP20
Swivel angle	90°
Rotation angle	360°
Track type	Track 48V
Weight	310 g.
Packaged weight	380 g.
Packaging dimensions	188 x 165 x 53 mm.
Units per package	1
Materials	Aluminium / Polycarbonate



Fit 48V, is a spotlight for low voltage tracklight applications which is available in five sizes (ø50, ø35, ø35 double, ø20 and ø20 double). Cylindrical geometry and essential forms, it stands out for its minimalistic looking and its functionality as it can be orientated in any direction. The black perimeter around its mouth and its honeycomb accessory, highlights its anti-glare vocation.

POLAR DIAGRAM

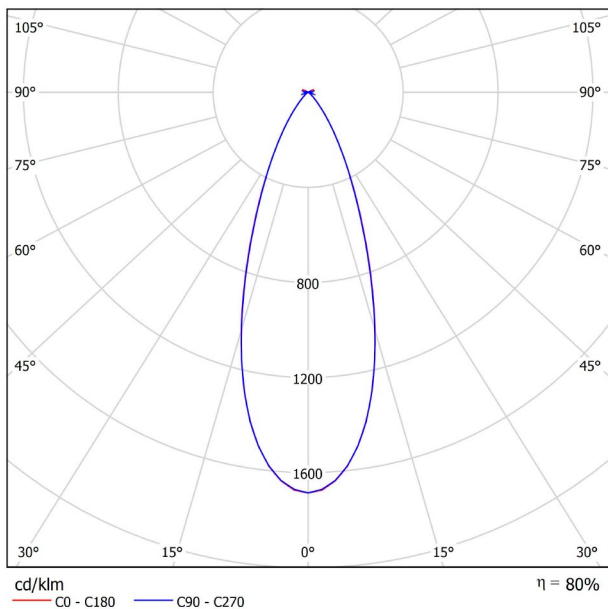

CONICAL DIAGRAM

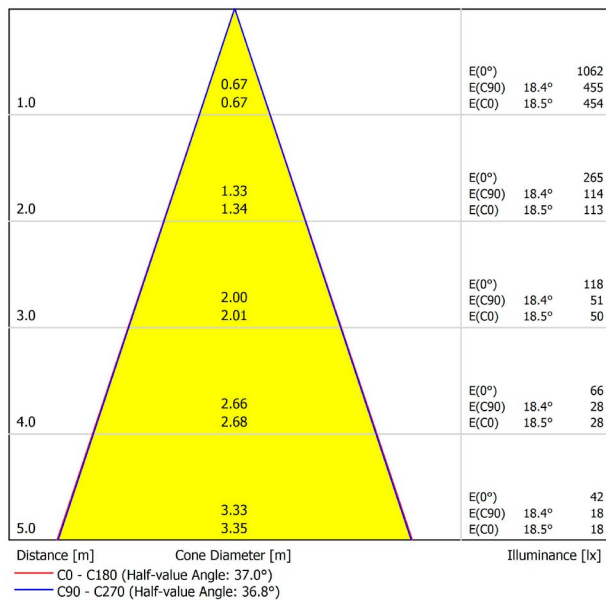

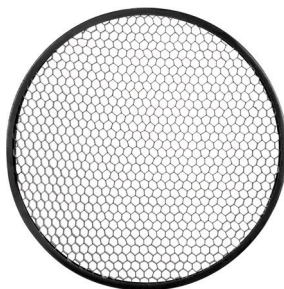

	PRODUCT
Model	Anti-glare Honeycomb Louver
Reference	A345-00-00
Category	Accessories

NOT SOLD SEPARATELY.



Accessory made up of louver in the shape of a honeycomb panel to reduce glare and the effects of direct rays of vision.

# TRACK 48V TRIMLESS

**ARKOSLIGHT®**

## TRACK 48V SURFACE

Available on request. Please consult.

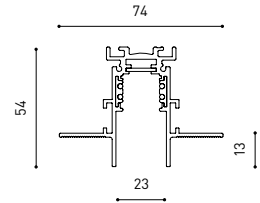

TRACK 48V 1M	A338-01-00-   N
TRACK 48V 2M	A338-02-00-   N
TRACK 48V 3M	A338-03-00-   N
TRACK 48V Corner 90° One Plane	A338-04-00-   N
TRACK 48V Corner 90° Two Planes	A338-05-00-   N

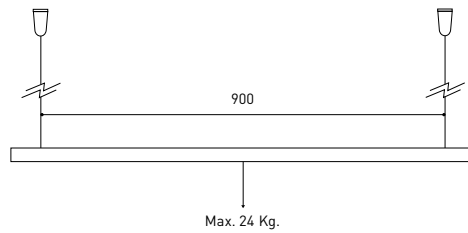

		P	I	D	
CONSTANT VOLTAGE LED POWER SUPPLY	NO DIM	0434-01-21	75W	48V	180 x 52 x 30mm
		0434-01-22	150W	48V	240 x 60 x 49mm
	DALI	0434-01-19	75W	48V	235 x 100 x 31mm
		0434-01-20	150W	48V	235 x 100 x 31mm

### CABLE SECTION AND LENGTH BETWEEN TRACK 48V AND POWER SUPPLY

TRACK LENGTH (m)		10			20		29
CABLE LENGTH (m)		1	10	20	1	10	1
POWER (W)	CABLE SECTION (mm²)						
75W	0,75mm²	✓	✓	✓	✓	✓	✓
	1,5mm²	✓	✓	✓	✓	✓	✓
150W	0,75mm²	✓	X	X	✓	X	✓
	1,5mm²	✓	✓	X	✓	✓	✓

COLOUR | N ■ RAL 9005 |

Recommended for installations where the profile can be installed before the false plasteboard ceiling (thickness 12,5mm.)



# TRACK 48V TRIMLESS

**ARKOSLIGHT®**

## TRACK 48V SURFACE

Available on request. Please consult.

**TRACK 48V 90° CORNER One Plane**

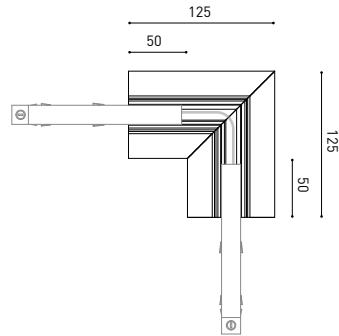

\*Electrical connection included

**TRACK 48V 90° CORNER Two Planes**

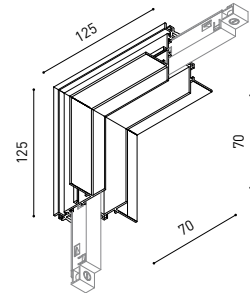

\*Electrical connection included

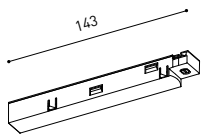

**TRACK 48V Live-End Connector**

A338-00-01- | N |



**TRACK 48V End**

A338-00-06- | N |

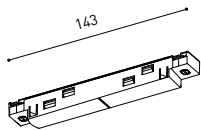

**TRACK 48V Central Connector**

A338-00-02- | N |



**TRACK 48V End Feed**

A338-00-07- | N |



**TRACK 48V Short T-Bracket**

A338-00-03

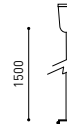

**TRACK 48V Suspension Kit**

A338-00-08

See accessories quantities\*

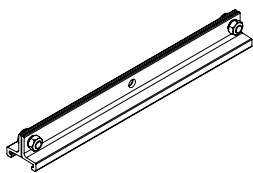

**TRACK 48V Long T-Bracket**

A338-00-04



**TRACK 48V Clamp for M6 ROD**

A338-00-09

See accessories quantities\*

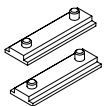

**TRACK 48V Straight Joiners (2 Units)**

A338-00-05



**TRACK 48V Track Clamp**

A338-00-10

See accessories quantities\*

**\* SUGGESTED MOUNTING ACCESSORIES QUANTITIES**

1000 mm - 2 Pcs.  
2000 mm - 3 Pcs.  
3000 mm - 4 Pcs.

COLOUR | N ■ RAL 9005 |

Recommended for installations where the profile can be installed before the false plasteboard ceiling (thickness 12,5mm.)