

THIS DRAWING IS FOR CUSTOMER APPROVAL ONLY

RETURN EMAIL: ESALES@PARLEC.COM
RETURN FAX: 1-800-866-5917

PLEASE NOTE: 1) PARLEC WARRANTIES ALL STANDARD TOOLING AND/OR COMPONENTS. ON ALL SPECIAL CUSTOMER DEFINED TOOLS AND COMPONENTS, PARLEC WARRANTIES ONLY THE ACCURACY OF THE SPECIFICATIONS NOTED ON THE APPROVAL DOCUMENT. THE FUNCTIONALITY OF CUSTOMER DEFINED COMPONENTS (SPECIALS) ARE SOLELY THE RESPONSIBILITY OF THE CUSTOMER. 2) PRICING & DELIVERY IS BASED ON THIS CONCEPT. ANY CUSTOMER CHANGES DURING THE APPROVAL PROCESS MAY RESULT IN CHANGES TO PRICE AND LEAD-TIMES.

SIGNATURE _____

DATE _____

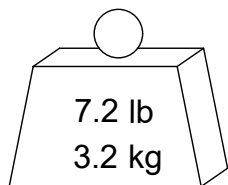
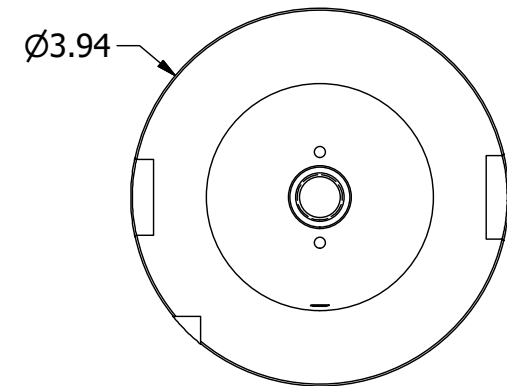
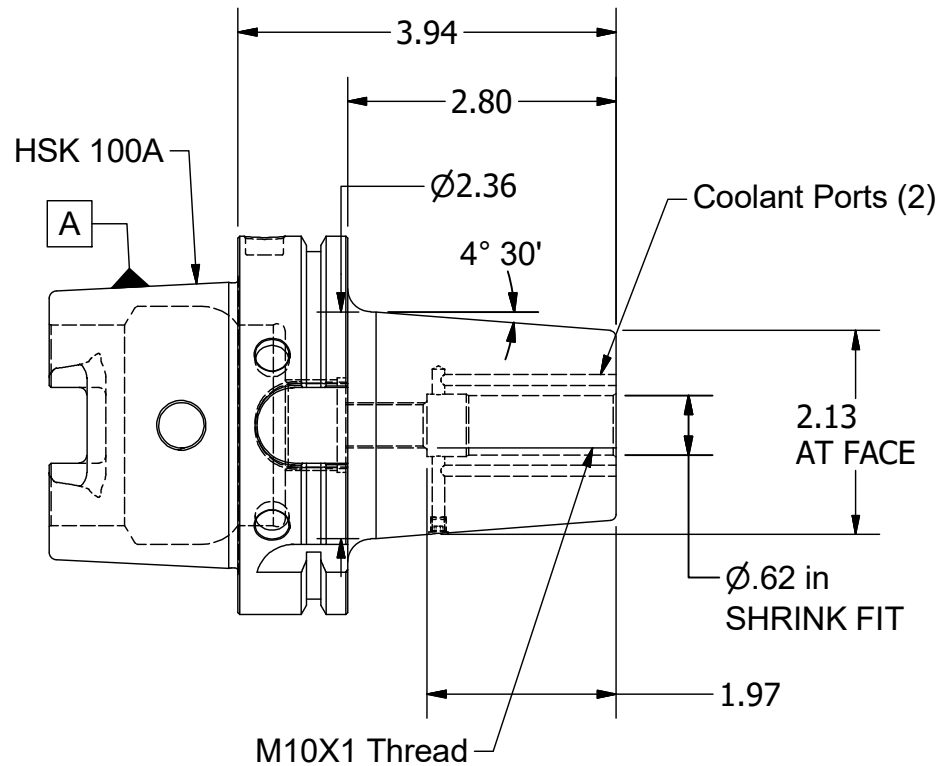
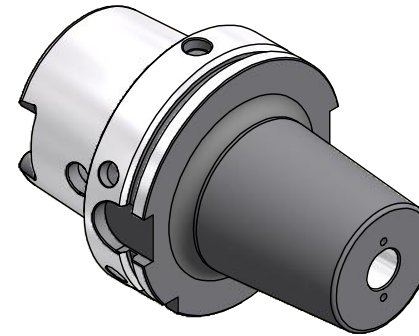

PART
NUMBER

H100A-62SHD394-9C

PARLEC
(800) TOOL USA
WORLD HEADQUARTERS
101 PERINTON PARKWAY
FAIRPORT, NEW YORK 14450

