

Parts List

ITEM	QTY	PART NUMBER	DESCRIPTION
1	2	32MMKY	KEY, SHELL MILL HOLDER
2	1	32MMLS	LOCK SCREW, SHELL MILL HOLDER
3	2	028-166	CAP SCREW, M5X0.8 X 12mm LG.

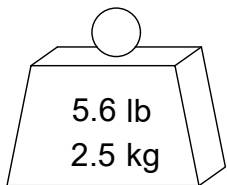
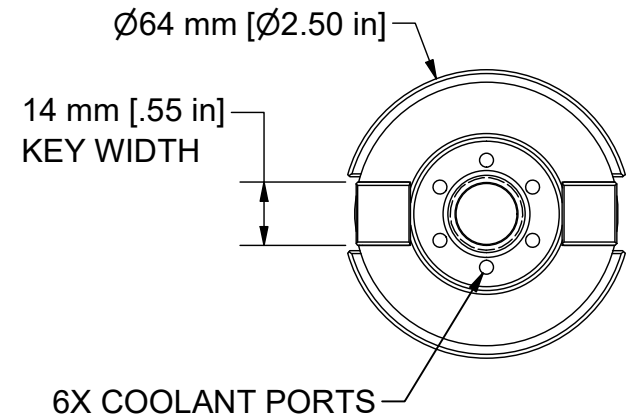
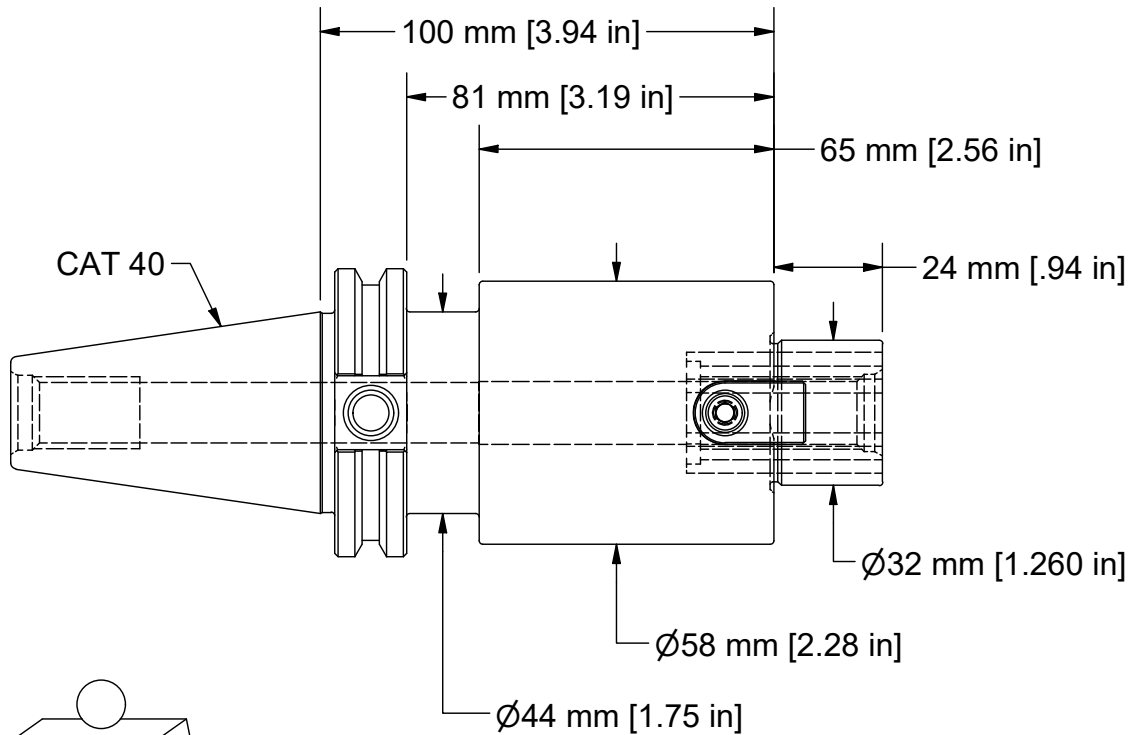
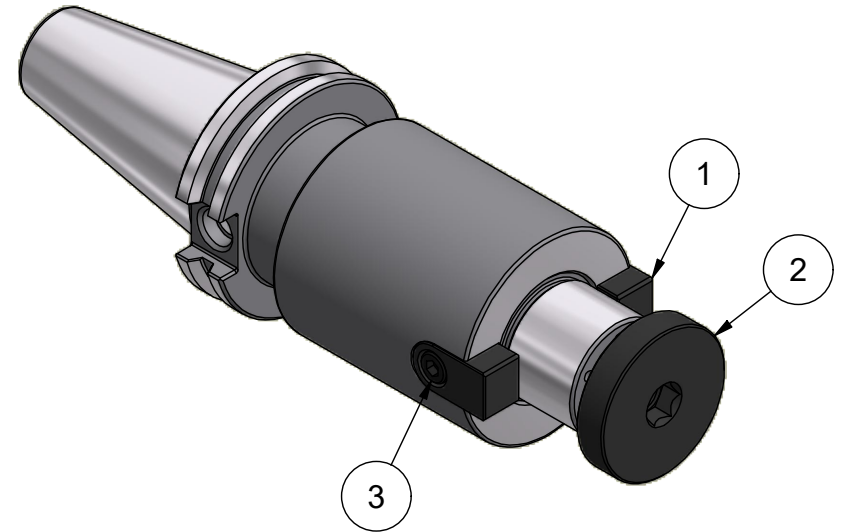

PART NUMBER

C40-M32SM100C

PARLEC
 (800) TOOL USA
 WORLD HEADQUARTERS
 101 PERINTON PARKWAY
 FAIRPORT, NEW YORK 14450