

Parts List

ITEM	QTY	PART NUMBER	DESCRIPTION	
1	1	BS-SFM101-20	ADJUSTING SCREW	OPTIONAL

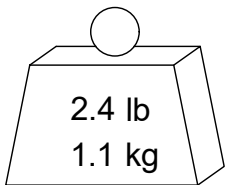
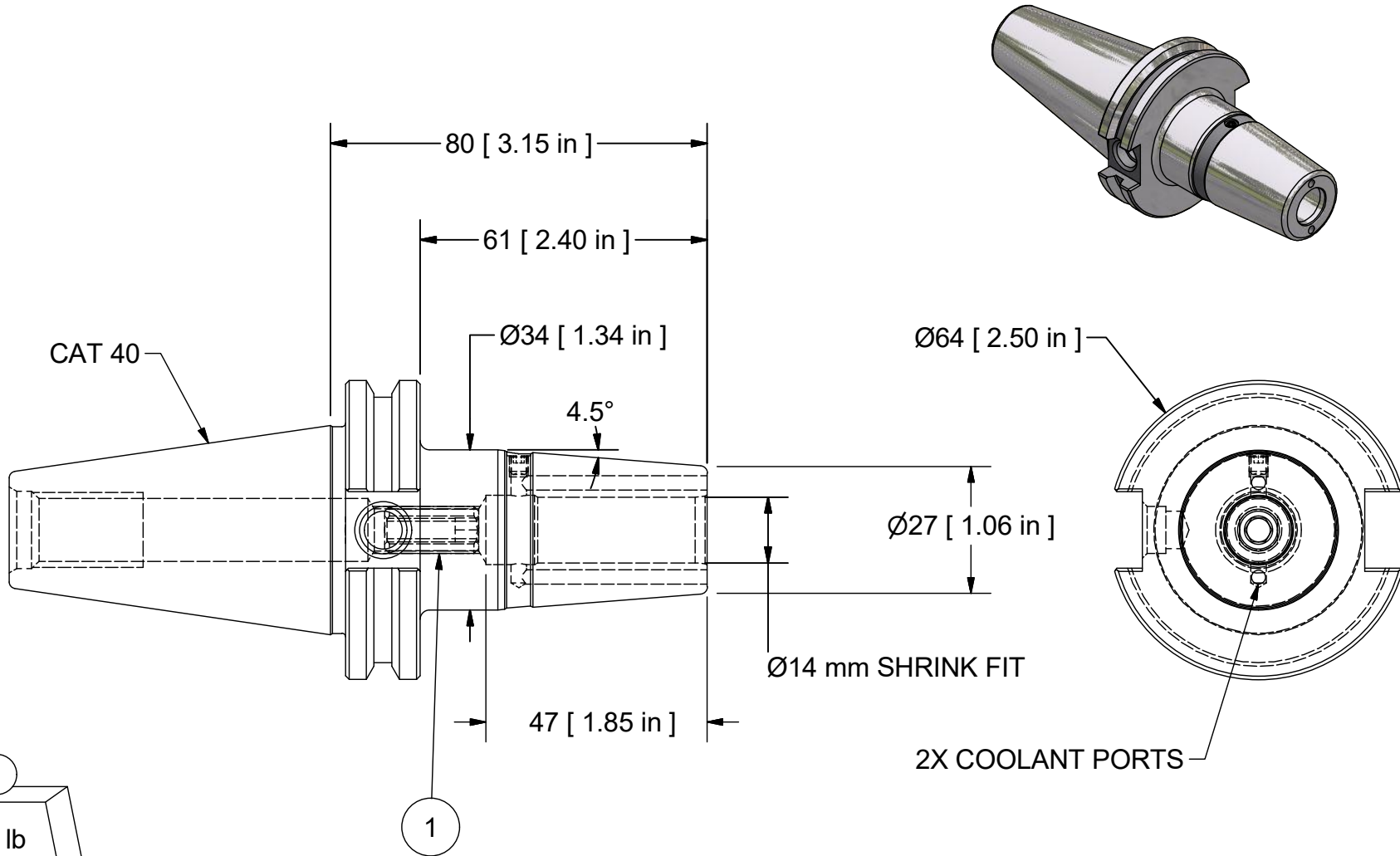

BALANCE
G2.5 @ 20,000 RPM

PART NUMBER
C40A-M14SF80-9C

PARLEC
(800) TOOL USA
WORLD HEADQUARTERS
101 PERINTON PARKWAY
FAIRPORT, NEW YORK 14450