

Parts List

ITEM	QTY	PART NUMBER	DESCRIPTION	
2	1	BS-SFM121-20	ADJUSTING SCREW	OPTIONAL
1	1	029-060	SET SCREW, M4X.7 X 4MM	

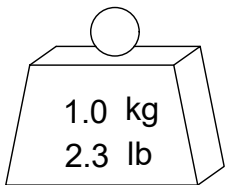
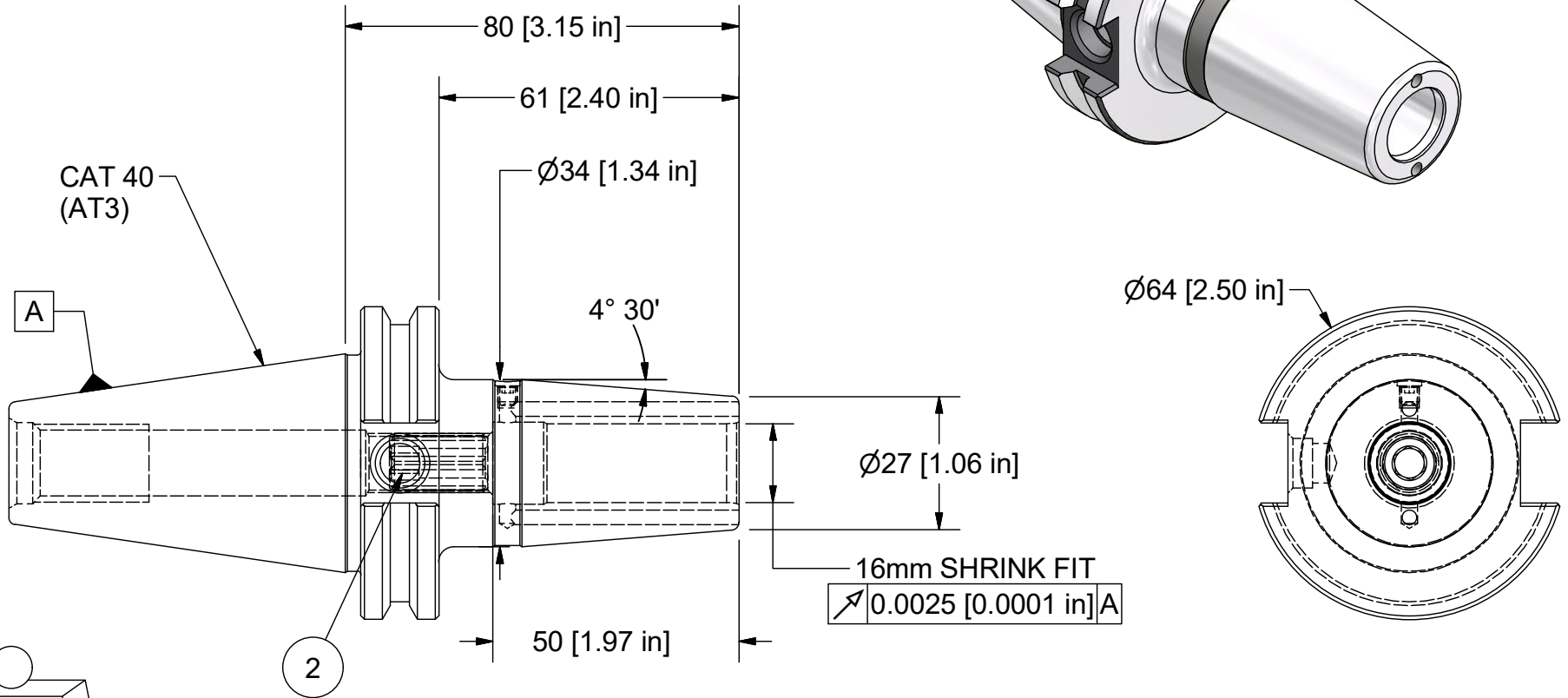
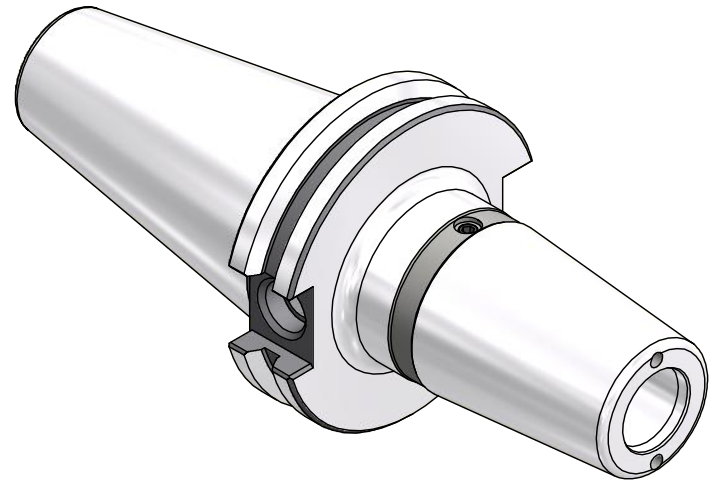

BALANCE
G2.5 @ 20,000 RPM

PART
NUMBER

C40A-M16SF80-9C

PARLEC
 (800) TOOL USA
 WORLD HEADQUARTERS
 101 PERINTON PARKWAY
 FAIRPORT, NEW YORK 14450