

Parts List

ITEM	QTY	PART NUMBER	DESCRIPTION
1	2	22MMKY	KEY, SHELL MILL HOLDER
2	1	27MMLS	LOCK SCREW, SHELL MILL HOLDER
3	2	028-197	CAP SCREW, M4 x 10

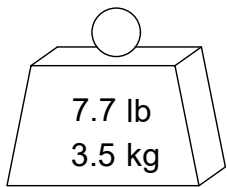
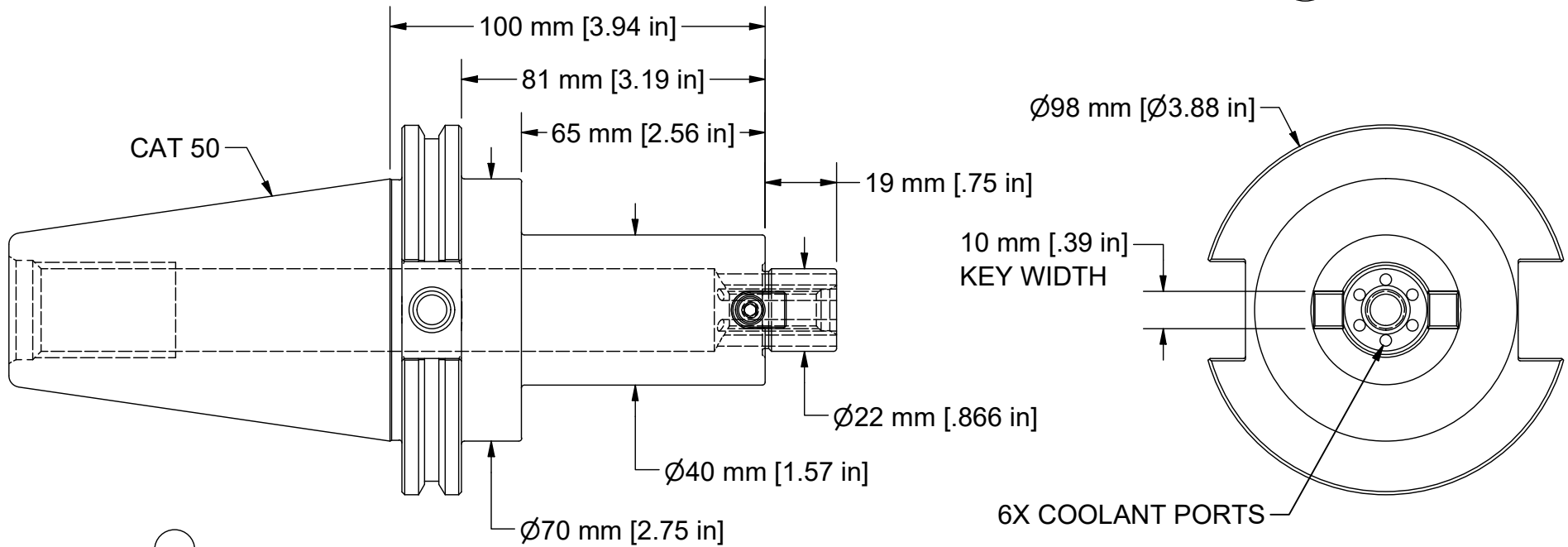
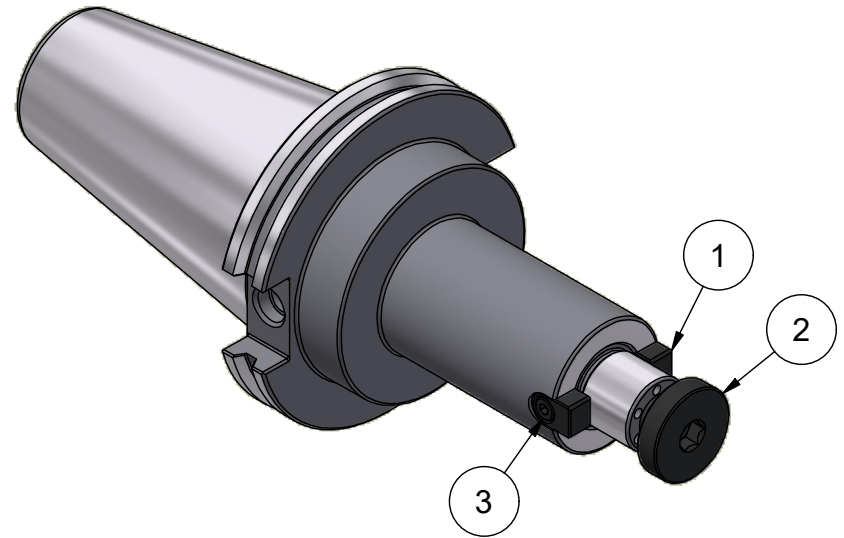

PART
NUMBER

C50-M22SM100C

PARLEC
 (800) TOOL USA
 WORLD HEADQUARTERS
 101 PERINTON PARKWAY
 FAIRPORT, NEW YORK 14450