

Parts List			
ITEM	QTY	PART NUMBER	DESCRIPTION
1	1	028-188	SHCS 1/2-20-1 1/4
2	2	10KY	DRIVE KEY
3	1	10LS	LOCK SCREW
4	2	029-966	SET SCREW, M6 x 5 W/360 DEG. PATCH

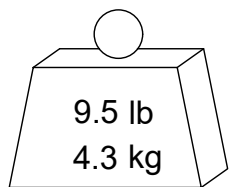
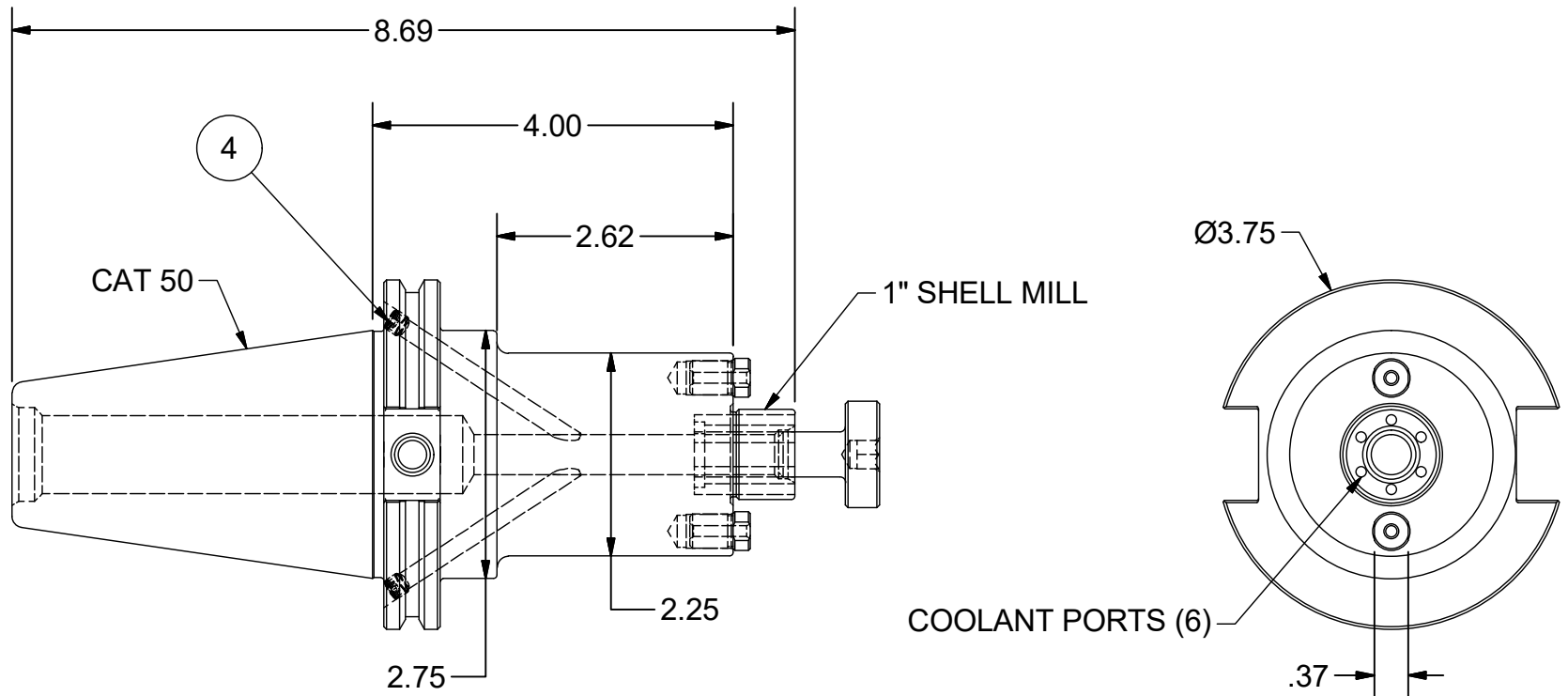
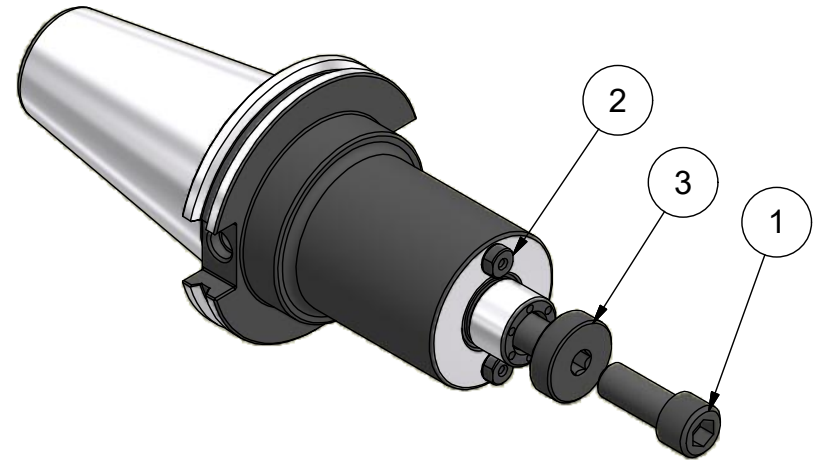

PART
NUMBER

C50BC-10SM400C

PARLEC
 (800) TOOL USA
 WORLD HEADQUARTERS
 101 PERINTON PARKWAY
 FAIRPORT, NEW YORK 14450