

Parts List

ITEM	QTY	PART NUMBER	DESCRIPTION
1	2	22MMKY	KEY, SHELL MILL HOLDER
2	1	22MMLS	LOCK SCREW, SHELL MILL HOLDER
3	2	028-197	CAP SCREW, M4 x 10

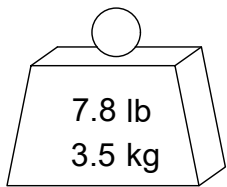
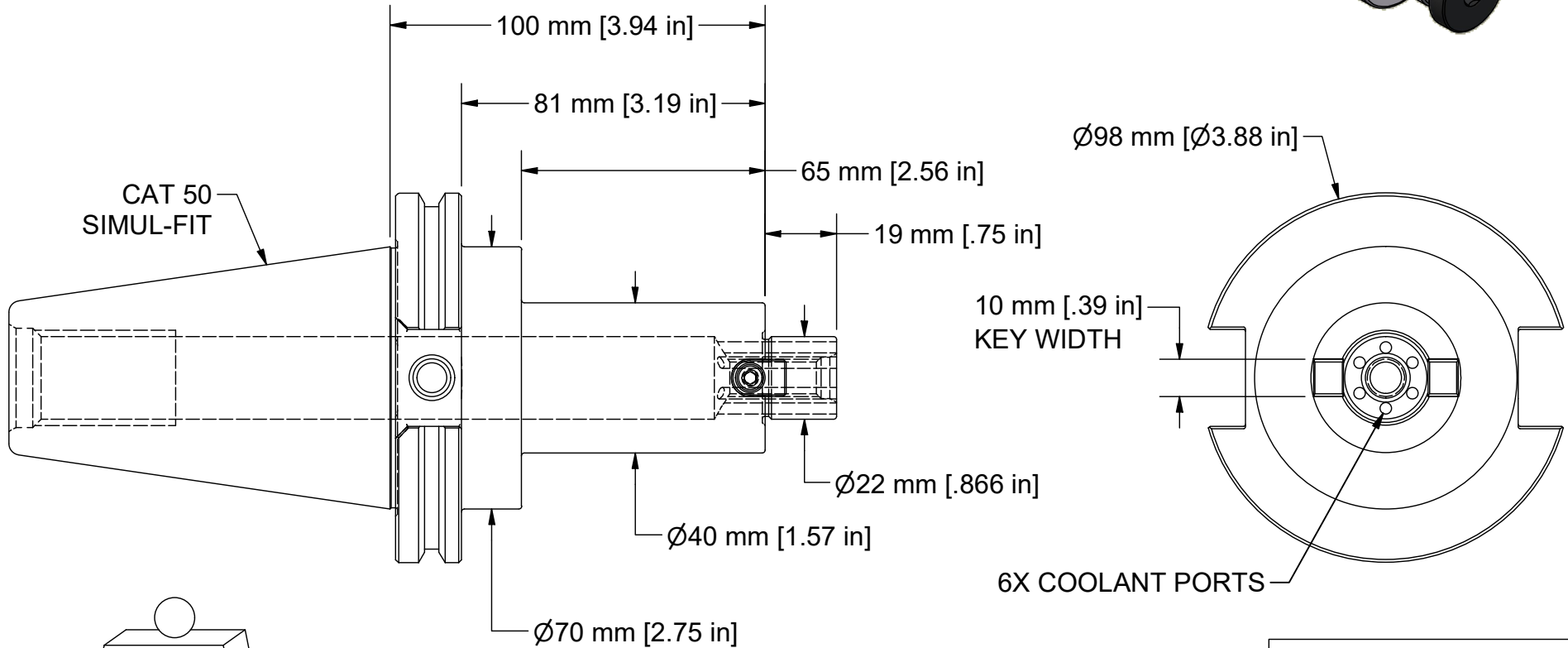
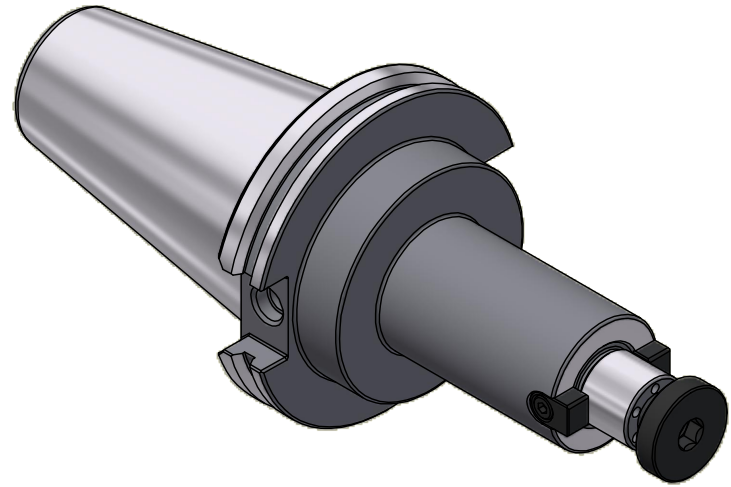

PART NUMBER

C50F-M22SM100C

**PARLEC**  
 (800) TOOL USA  
 WORLD HEADQUARTERS  
 101 PERINTON PARKWAY  
 FAIRPORT, NEW YORK 14450