

Parts List

ITEM	QTY	PART NUMBER	DESCRIPTION
1	2	32MMKY	KEY, SHELL MILL HOLDER
2	1	32MMLS	LOCK SCREW, SHELL MILL HOLDER
3	2	028-166	CAP SCREW, M5X0.8 X 12mm LG.

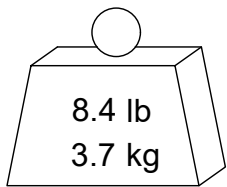
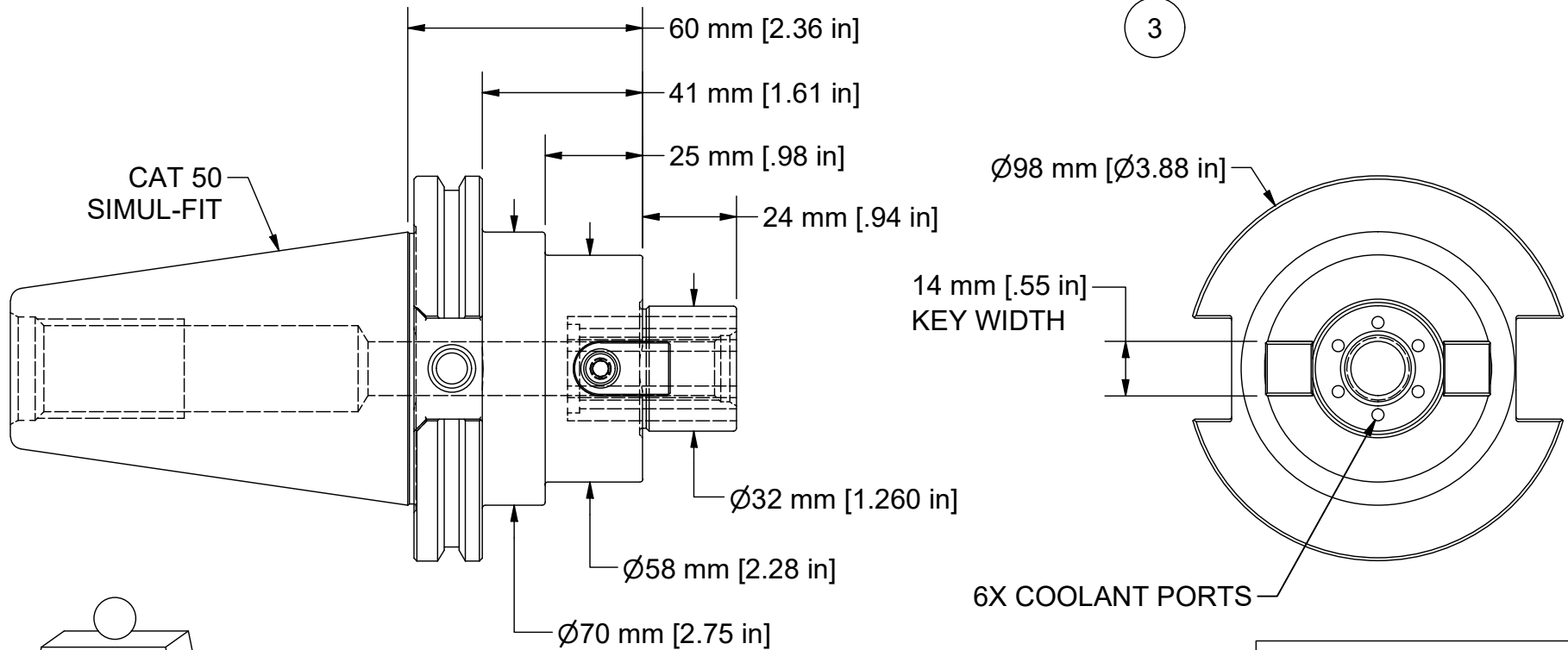
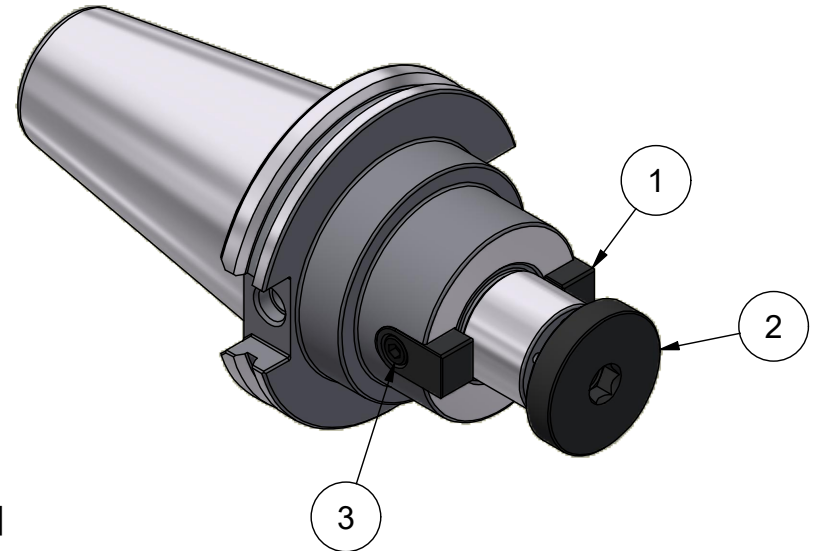

PART NUMBER

C50F-M32SM60C

**PARLEC**  
 (800) TOOL USA  
 WORLD HEADQUARTERS  
 101 PERINTON PARKWAY  
 FAIRPORT, NEW YORK 14450