

Parts List

ITEM	QTY	PART NUMBER	DESCRIPTION
1	2	12KY	DRIVE KEY
2	1	12LS	LOCK SCREW
3	1	028-193	SHCS 5/8-18 x 1-1/4

THIS DRAWING IS FOR CUSTOMER APPROVAL ONLY

RETURN EMAIL: ESALES@PARLEC.COM  
RETURN FAX: 1-800-866-5917

PLEASE NOTE: 1) PARLEC WARRANTS ALL STANDARD TOOLING AND/OR COMPONENTS. ON ALL SPECIAL CUSTOMER DEFINED TOOLS AND COMPONENTS, PARLEC WARRANTS ONLY THE ACCURACY OF THE SPECIFICATIONS NOTED ON THE APPROVAL DOCUMENT. THE FUNCTIONALITY OF CUSTOMER DEFINED COMPONENTS (SPECIALS) ARE SOLELY THE RESPONSIBILITY OF THE CUSTOMER. 2) PRICING & DELIVERY IS BASED ON THIS CONCEPT. ANY CUSTOMER CHANGES DURING THE APPROVAL PROCESS MAY RESULT IN CHANGES TO PRICE AND LEAD-TIMES.

SIGNATURE \_\_\_\_\_

DATE \_\_\_\_\_

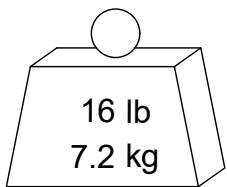
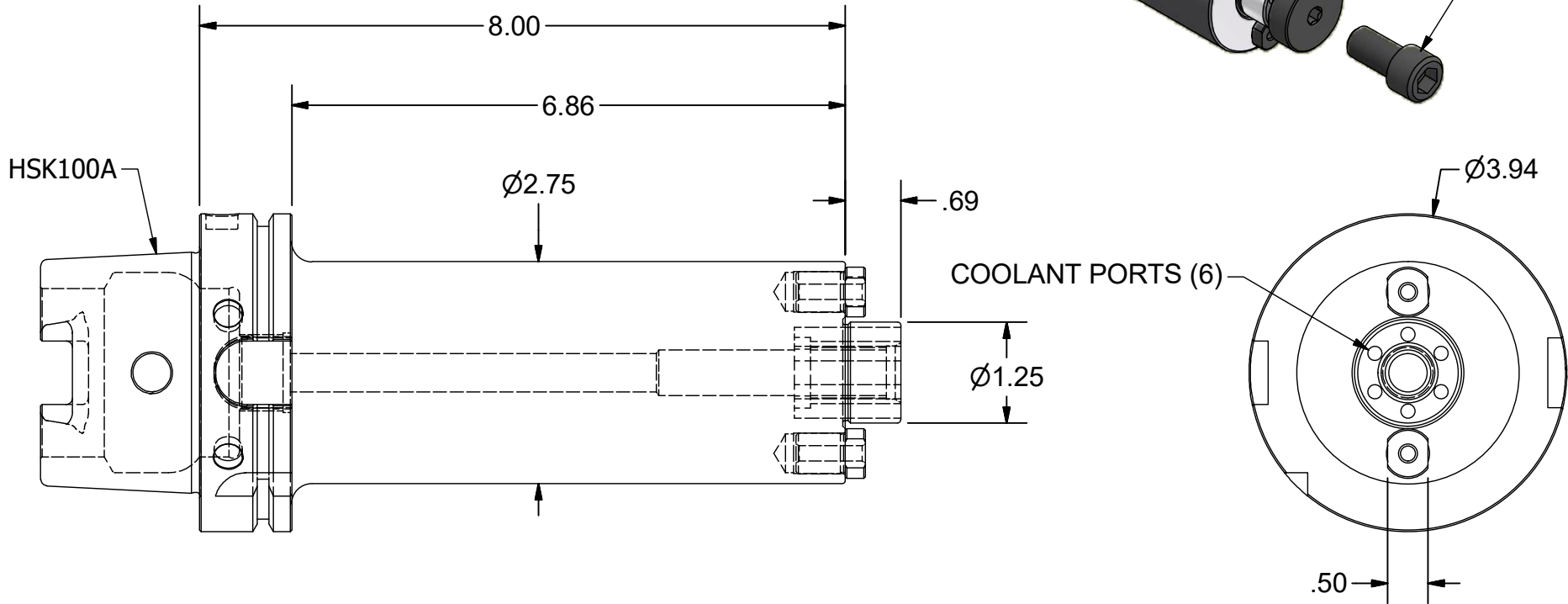
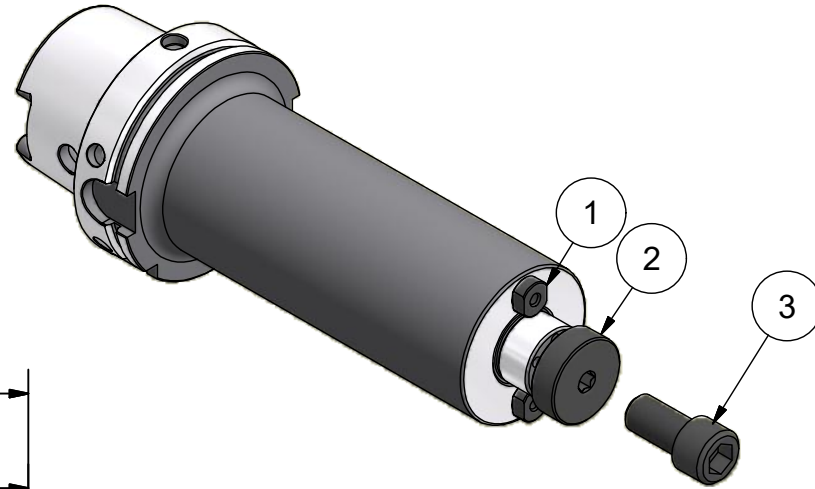

PART NUMBER

H100A-12SM800C

**PARLEC**  
(800) TOOL USA  
WORLD HEADQUARTERS  
101 PERINTON PARKWAY  
FAIRPORT, NEW YORK 14450