

Parts List

ITEM	QTY	PART NUMBER	DESCRIPTION	
1	1	BS-SFM161-20	ADJUSTING SCREW	OPTIONAL

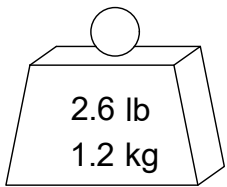
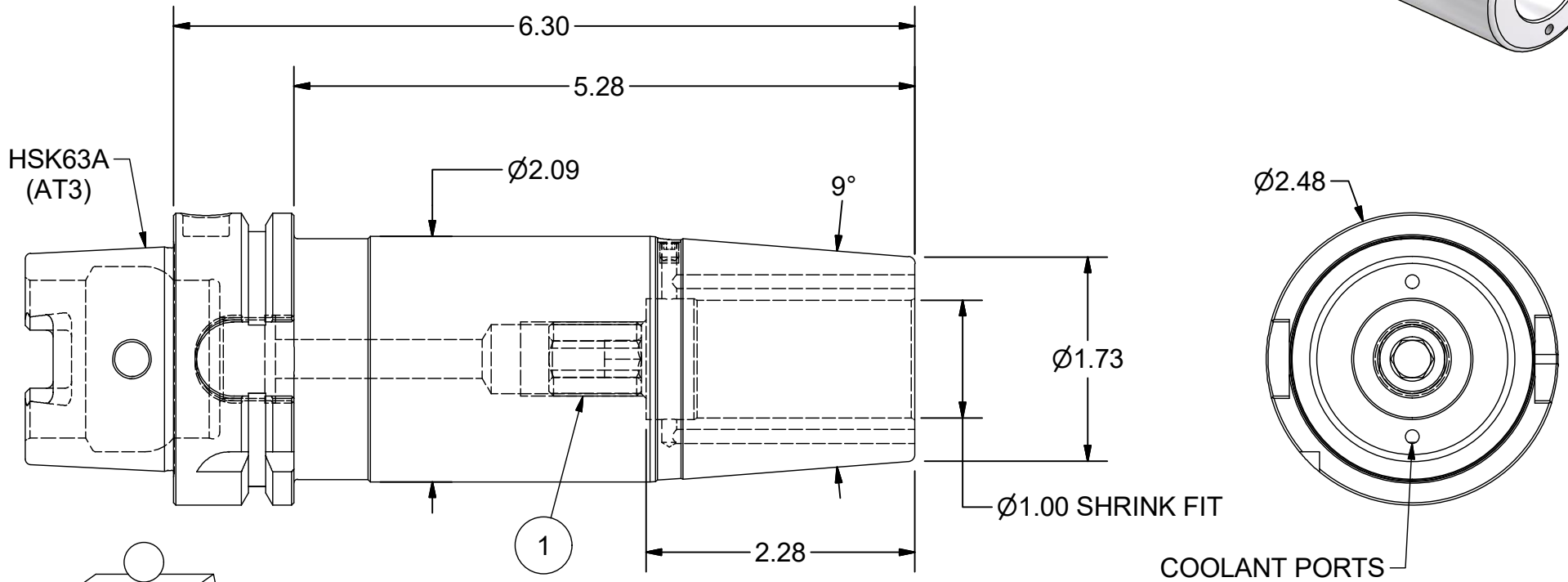
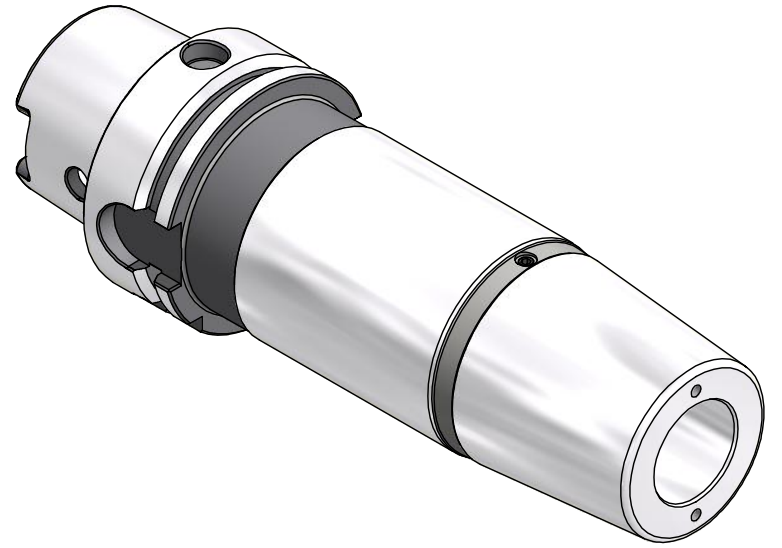

BALANCE
G2.5 @ 20,000 RPM

PART NUMBER
H63A-10SF630-9C

PARLEC
(800) TOOL USA
WORLD HEADQUARTERS
101 PERINTON PARKWAY
FAIRPORT, NEW YORK 14450