

Parts List

ITEM	QTY	PART NUMBER	DESCRIPTION	
1	1	BS-SFM081-16	ADJUSTING SCREW	OPTIONAL

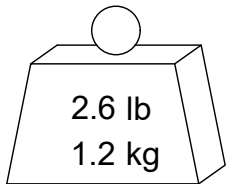
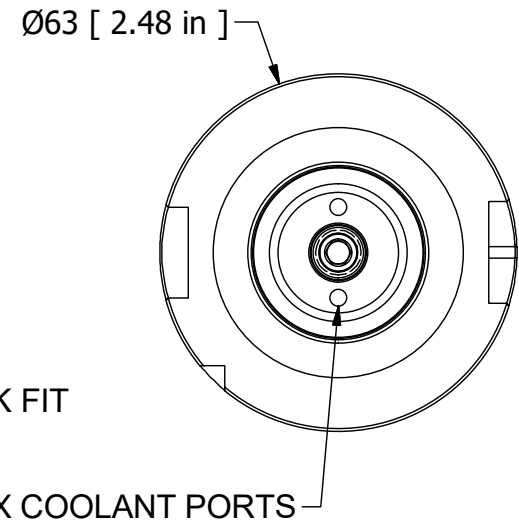
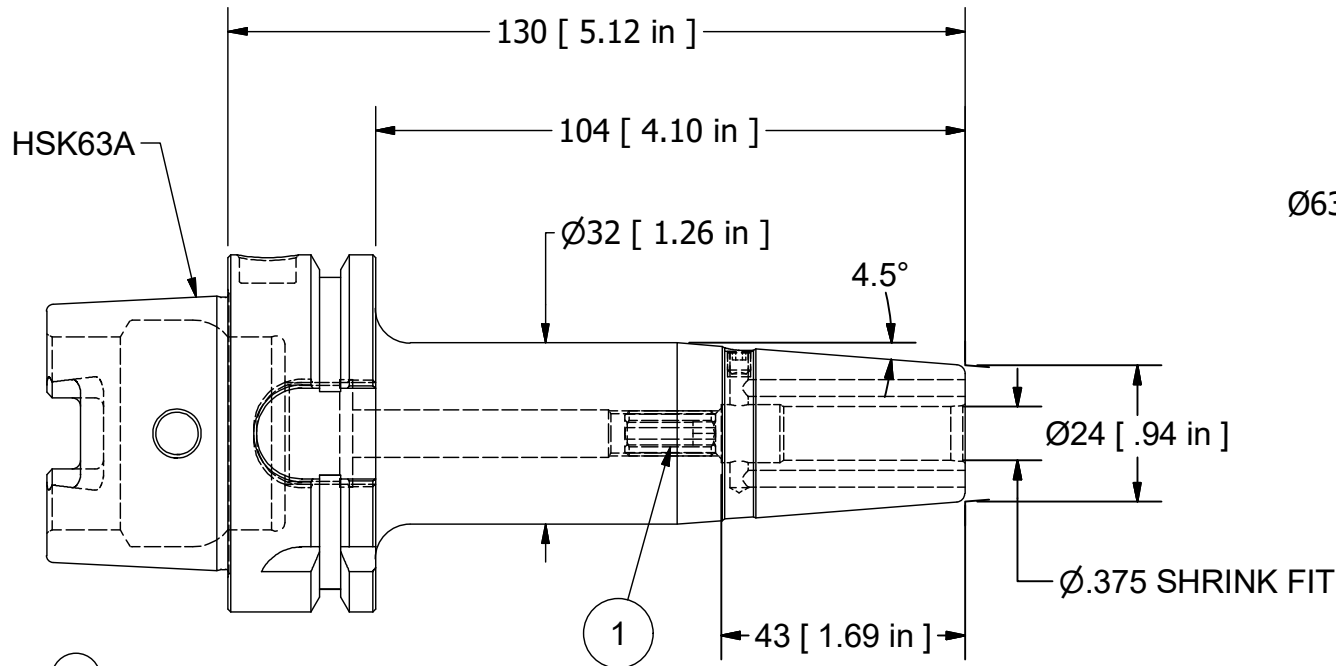
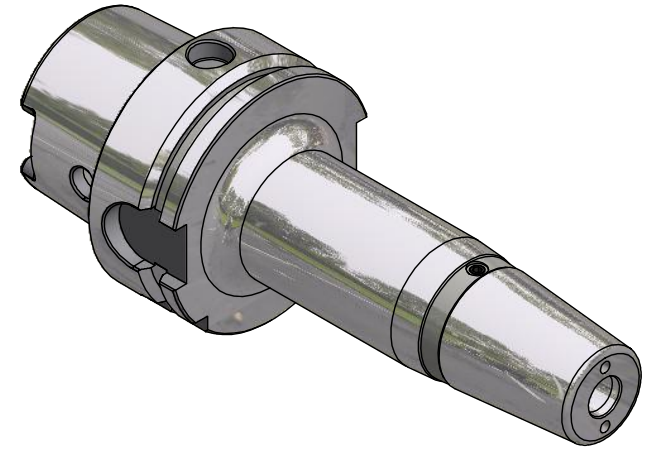

BALANCE
G2.5 @ 20,000 RPM

PART NUMBER
H63A-38SF512-9C

PARLEC
 (800) TOOL USA
 WORLD HEADQUARTERS
 101 PERINTON PARKWAY
 FAIRPORT, NEW YORK 14450