

Parts List

ITEM	QTY	PART NUMBER	DESCRIPTION	
1	1	BS-SFM161-18	ADJUSTING SCREW	OPTIONAL
1	1	029-060	SET SCREW, M4X.7 X 4MM	

DIN	69893-1
DIN	69882-8

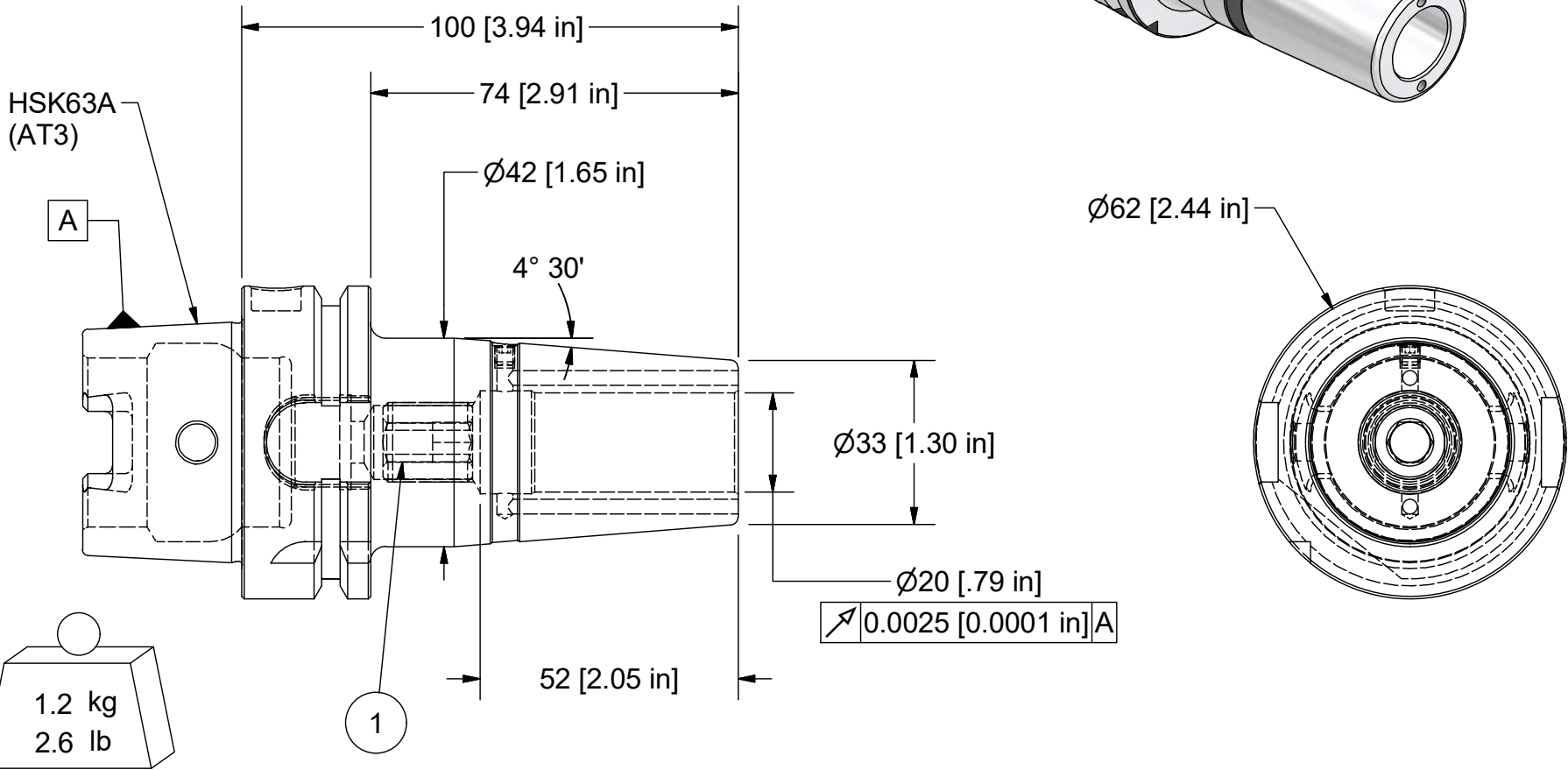
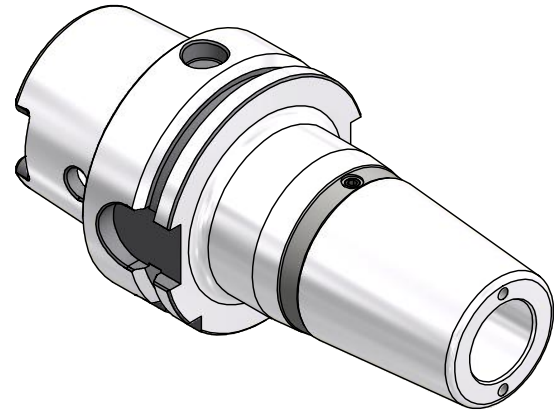

BALANCE
G2.5 @ 20,000 RPM

PART
NUMBER

H63A-M20SF100-9C

PARLEC
 (800) TOOL USA
 WORLD HEADQUARTERS
 101 PERINTON PARKWAY
 FAIRPORT, NEW YORK 14450