

Parts List

ITEM	QTY	PART NUMBER	DESCRIPTION	
1	1	BS-SFM161-20	ADJUSTING SCREW	OPTIONAL
1	1	029-060	SET SCREW, M4X.7 X 4MM	

DIN	69893-1
DIN	69882-8

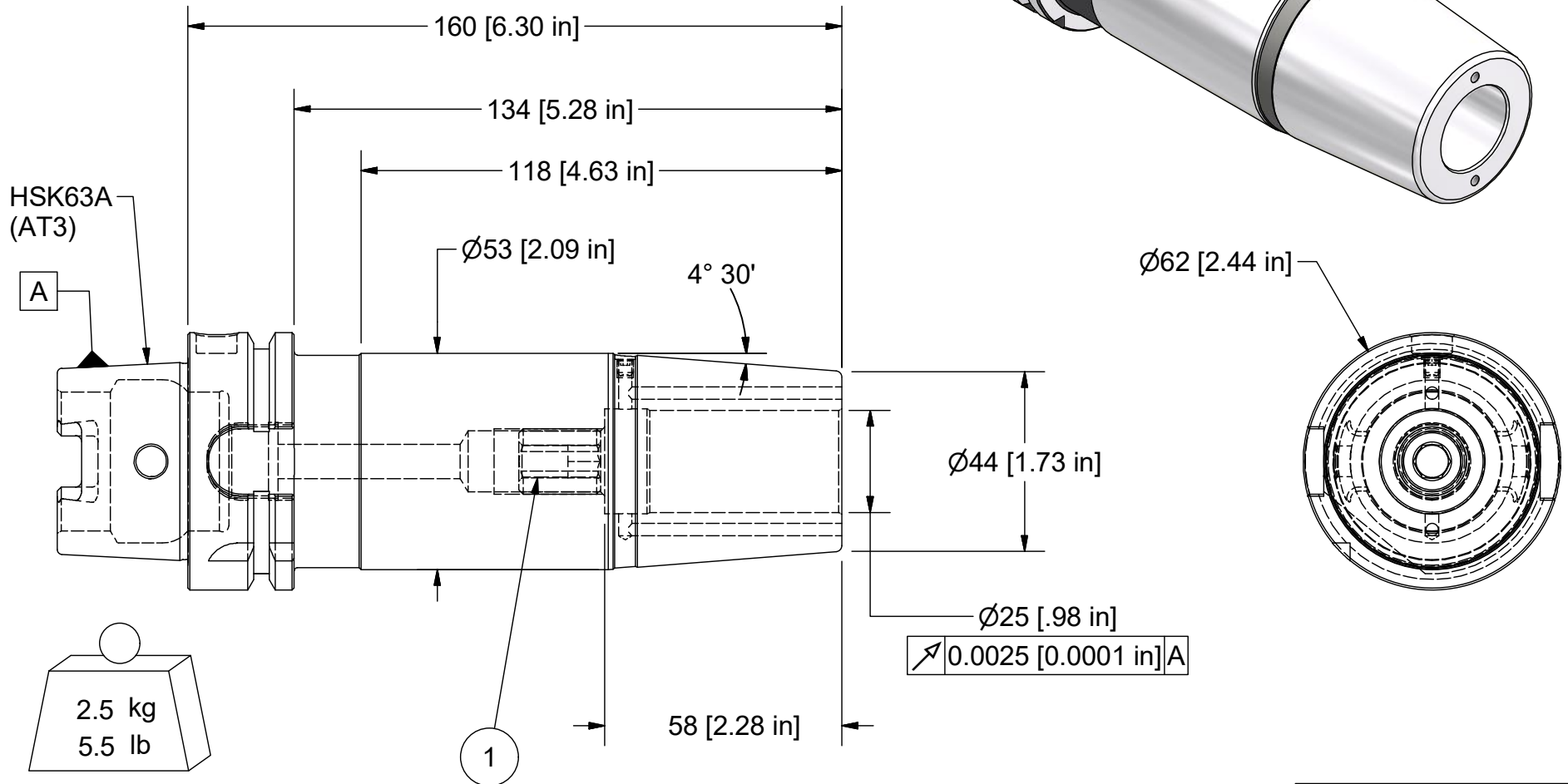
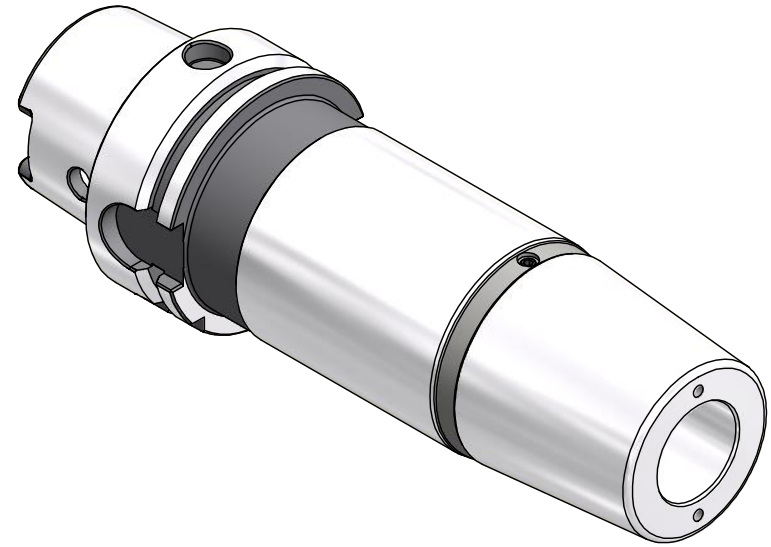

BALANCE  
G2.5 @ 20,000 RPM

PART  
NUMBER

H63A-M25SF160-9C

**PARLEC**  
 (800) TOOL USA  
 WORLD HEADQUARTERS  
 101 PERINTON PARKWAY  
 FAIRPORT, NEW YORK 14450