

Parts List

ITEM	QTY	PART NUMBER	DESCRIPTION
1	2	27MMKY	KEY, SHELL MILL HOLDER
2	1	27MMLS	LOCK SCREW, SHELL MILL HOLDER
3	2	028-166	CAP SCREW, M5X0.8 X 12mm LG.

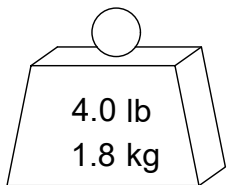
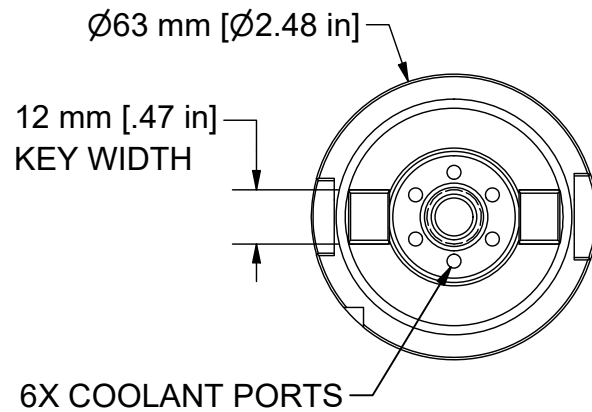
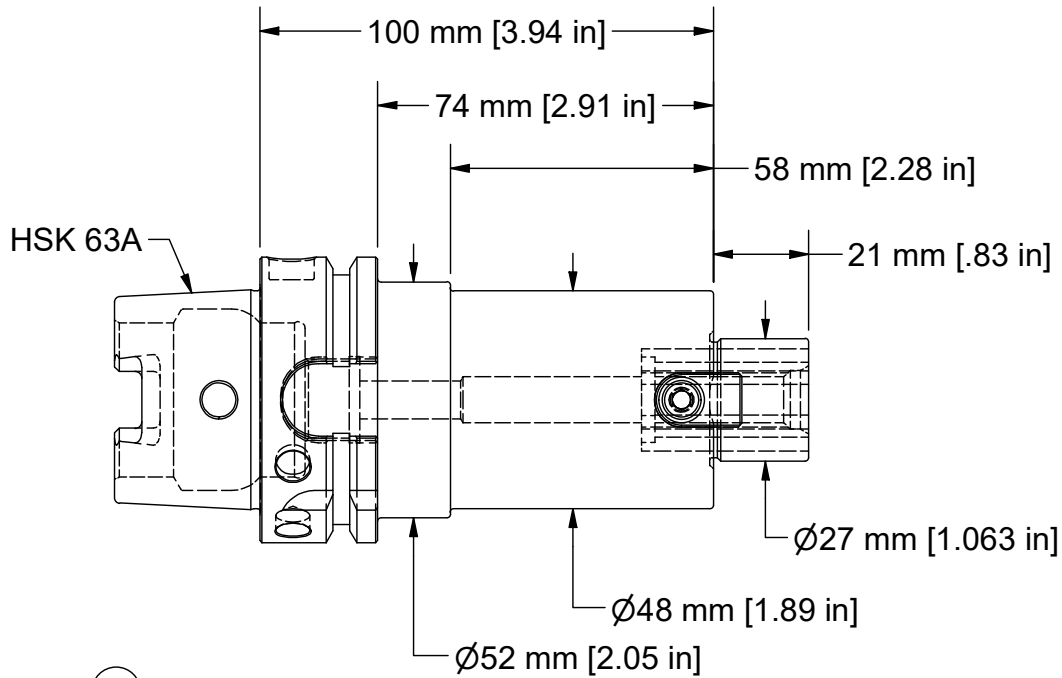
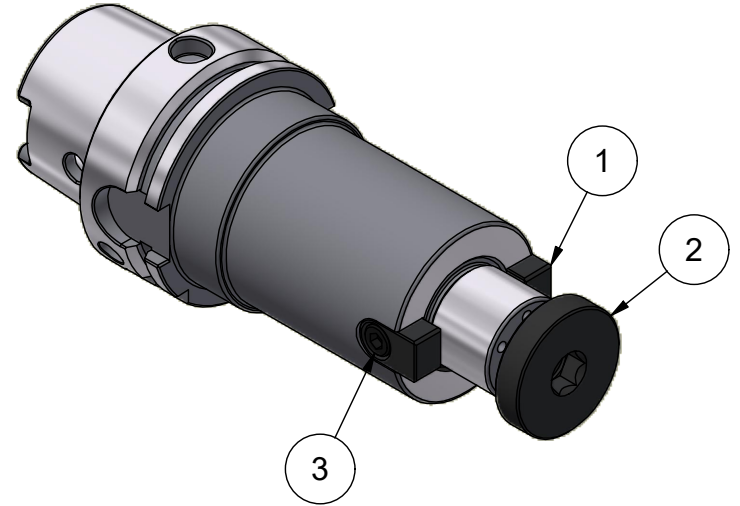

PART NUMBER

**H63A-M27SM100C**

**PARLEC**  
 (800) TOOL USA  
 WORLD HEADQUARTERS  
 101 PERINTON PARKWAY  
 FAIRPORT, NEW YORK 14450