

Standard Installation



Flammable



Warning



High Voltage



Hot Surface

TOOLS NEEDED:	Waterproof Wire Connectors
--------------------------	----------------------------

**INSTRUCTIONS PERTAINING TO
A RISK OF FIRE, OR INJURY
TO PERSONS IMPORTANT SAFETY
INSTRUCTIONS**

Lighted fixture is HOT!

**WARNING - To reduce the risk of
FIRE OR INJURY TO PERSONS:**

Turn off/unplug and allow to cool before replacing lamp/LED. Fixture gets HOT quickly! Contact only switch/plug when turning on. Do not touch hot lens, guard, or enclosure. Keep fixture away from materials that may burn. Do not operate the luminaire fitting with a missing or damaged shield. Do not touch the source at any time. Use a soft cloth or gloves. Oil from skin may cause damage.

SAVE THESE INSTRUCTIONS

**IMPORTANT SAFETY INFORMATION - READ, FOLLOW, AND SAVE ALL
SAFETY AND INSTALLATION INSTRUCTIONS**

- Product must be installed by a qualified person in a manner consistent with its intended use and in compliance with the National Electrical Code, Canadian Electrical Code, and all Local and Provincial Codes.
- Follow product label information and instructions.
- Qualified Personnel with appropriate personal protective equipment must perform all servicing of this product.
- Before wiring to power supply and during servicing, turn off and lock out power at fuse or circuit breaker before service.
- The use of accessory equipment not recommended by the manufacturer or installed contrary to instructions may cause an unsafe condition. The use of damaged components may cause an unsafe condition and void product warranty.
- Do not block light emanating from product in whole or part, as this may cause an unsafe condition.
- Never operate the fixture with missing or damaged lens. Lens must be cleaned on regular basis.
- Entire fixture may become extremely hot. Do not touch hot lens or fixture body.
- Replace LED assembly only with correct wattage and type of power supply appropriate for LED assembly.
- All gaskets, o-rings and sealing surfaces must be kept clean during installation and service; failure to do this may cause an unsafe condition and void product warranty.

IMPORTANT LISTINGS AND CERTIFICATIONS

- Suitable for wet locations
- Additionally suitable for mounting within 4 ft. of the ground

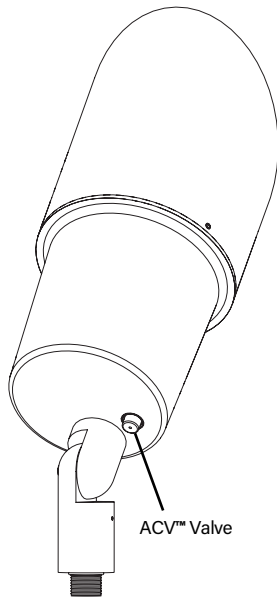

ACV™ Valve

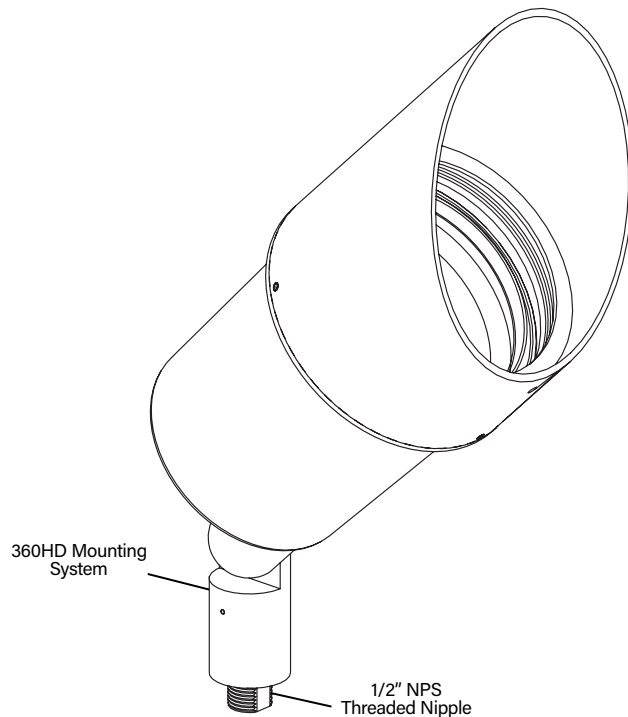

360HD Mounting System

1/2" NPS Threaded Nipple

**This set of instructions works for:
AL - Alps Series™**

Tenaya2® and its features are covered in whole or in part by U.S. Patent No. 7,175,297; U.S. Patent No. 7,033,038; U.S. Patent No. 6,254,258 B1; U.S. Patent No. 7,553,042; and U.S. Patent No. 7,560,148.

**IMPORTANT SAFETY INFORMATION - READ, FOLLOW, AND SAVE THESE INSTALLATION
INSTRUCTIONS**

B-K LIGHTING

40429 Brickyard Drive • Madera, CA 93636 • USA
559.438.5800 • FAX 559.438.5900
www.bklighting.com • info@bklighting.com

RELEASE DATE
09/16/2025

REFERENCE NUMBER
INS-1178-02

THIS DOCUMENT CONTAINS PROPRIETARY INFORMATION OF B-K LIGHTING, INC. AND ITS RECEIPT OR POSSESSION DOES NOT CONVEY ANY RIGHTS TO REPRODUCE, DISCLOSE ITS CONTENTS, OR TO MANUFACTURE, USE OR SELL ANYTHING IT MAY DESCRIBE. REPRODUCTION, DISCLOSURE OR USE WITHOUT SPECIFIC WRITTEN AUTHORIZATION OF B-K LIGHTING, INC. IS STRICTLY FORBIDDEN.

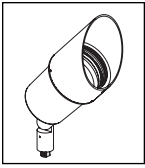

Standard Installation

Fixture Installation

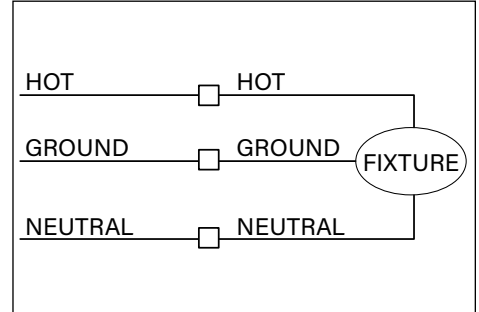
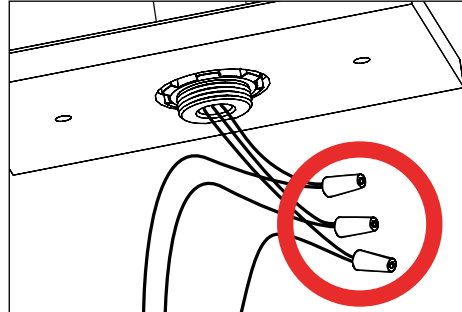
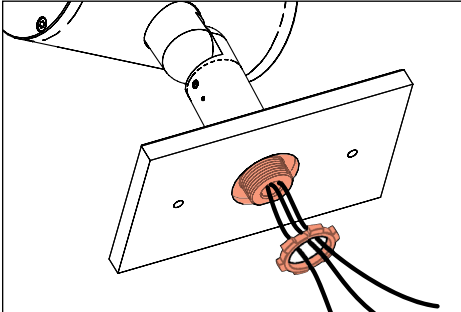

1. Mount fixture onto suitable enclosure according to designed lighting plan.
2. Secure ½" NPS stem to mounting option. Secure with provided locknut if applicable.

3. Make connections from primary branch circuit wiring to fixture leads using proper wire connectors (not included). Connect ground to ground wire from fixture. **See wiring diagram.**

WIRING DIAGRAM

**IMPORTANT SAFETY INFORMATION LISTED ON REVERSE
READ, FOLLOW, AND SAVE ALL SAFETY AND INSTALLATION INSTRUCTIONS**



B-K LIGHTING

40429 Brickyard Drive • Madera, CA 93636 • USA
559.438.5800 • FAX 559.438.5900
www.bklighting.com • info@bklighting.com

RELEASE DATE
09/16/2025

REFERENCE NUMBER
INS-1178-02

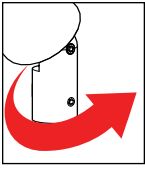

Standard Adjustment

360HD KNUCKLE MOUNTING SYSTEM



Flammable



Warning



Hot Surface

TOOLS NEEDED:

➤ 3/16" Allen wrench

INSTRUCTIONS PERTAINING TO A RISK OF FIRE, OR INJURY TO PERSONS IMPORTANT SAFETY INSTRUCTIONS

Lighted fixture is HOT!

WARNING - To reduce the risk of FIRE OR INJURY TO PERSONS:

Turn off/unplug and allow to cool before replacing lamp/LED. Fixture gets HOT quickly! Contact only switch/plug when turning on. Do not touch hot lens, guard, or enclosure. Keep fixture away from materials that may burn. Do not operate the luminaire fitting with a missing or damaged shield. Do not touch the source at any time. Use a soft cloth or gloves. Oil from skin may cause damage.

SAVE THESE INSTRUCTIONS

IMPORTANT SAFETY INFORMATION - READ, FOLLOW, AND SAVE ALL SAFETY AND INSTALLATION INSTRUCTIONS

- Product must be installed by a qualified person in a manner consistent with its intended use and in compliance with the National Electrical Code, Canadian Electrical Code, and all Local and Provincial Codes.
- Follow product label information and instructions.
- Qualified Personnel with appropriate personal protective equipment must perform all servicing of this product.
- Before wiring to power supply and during servicing, turn off and lock out power at fuse or circuit breaker before service.
- The use of accessory equipment not recommended by the manufacturer or installed contrary to instructions may cause an unsafe condition. The use of damaged components may cause an unsafe condition and void product warranty.
- Do not block light emanating from product in whole or part, as this may cause an unsafe condition.
- Never operate the fixture with missing or damaged lens. Lens must be cleaned on regular basis.
- Entire fixture may become extremely hot. Do not touch hot lens or fixture body.
- Replace LED assembly only with correct wattage and type of power supply appropriate for LED assembly.
- All gaskets, o-rings and sealing surfaces must be kept clean during installation and service; failure to do this may cause an unsafe condition and void product warranty.

IMPORTANT LISTINGS AND CERTIFICATIONS

- Suitable for wet locations • Additionally suitable for mounting within 4 ft. of the ground

360HD Knuckle Mounting System

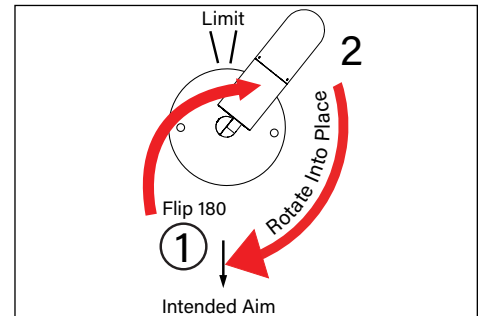
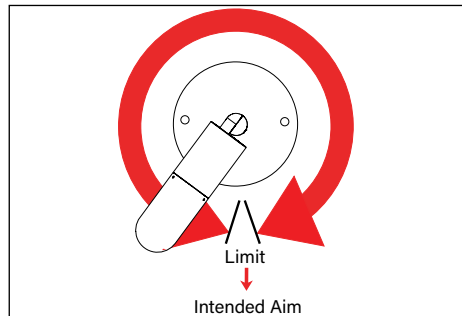
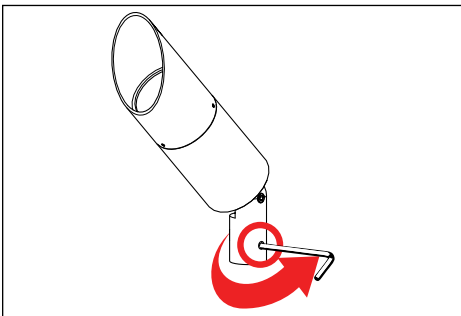

1. Use a 3/16" allen wrench to slightly loosen one (1) 3/8"-16 set screw on the knuckle for 360° aiming purpose.
2. Rotate fixture at base and aim fixture to desired horizontal location.
3. If the over-rotation protection pin is in the desired aiming position, do not force the fixture past the limit. Using a 3/16" allen wrench, slightly loosen both set screws in the knuckle, enough to move the fixture freely on both axes.
4. Flip the fixture 180 degrees over the knuckle. The rotational range limit will now be 180 degrees from the original position. Now rotate the fixture into the desired aiming position.
5. Secure aim by tightening one (1) 3/8"-16 set screw using a 3/16" allen wrench.

⚠ Rotating the cap may be necessary for proper weep hole and cutoff position

⚠ Warning: Do not over tighten cap set screws. Doing so will compromise o-ring seal and will void warranty.

IMPORTANT SAFETY INFORMATION - READ, FOLLOW, AND SAVE THESE INSTALLATION INSTRUCTIONS

B-K LIGHTING

40429 Brickyard Drive • Madera, CA 93636 • USA
559.438.5800 • FAX 559.438.5900
www.bklighting.com • info@bklighting.com

RELEASE DATE
09/16/2025

REFERENCE NUMBER
INS-2096-00

THIS DOCUMENT CONTAINS PROPRIETARY INFORMATION OF B-K LIGHTING, INC. AND ITS RECEIPT OR POSSESSION DOES NOT CONVEY ANY RIGHTS TO REPRODUCE, DISCLOSE ITS CONTENTS, OR TO MANUFACTURE, USE OR SELL ANYTHING IT MAY DESCRIBE. REPRODUCTION, DISCLOSURE OR USE WITHOUT SPECIFIC WRITTEN AUTHORIZATION OF B-K LIGHTING, INC. IS STRICTLY FORBIDDEN.

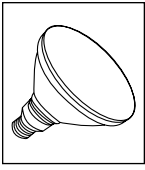

Lamp Instructions



TOOLS NEEDED:	➤ 5/32" Allen wrench
----------------------	----------------------

INSTRUCTIONS PERTAINING TO A RISK OF FIRE, OR INJURY TO PERSONS IMPORTANT SAFETY INSTRUCTIONS

Lighted fixture is HOT! WARNING - To reduce the risk of FIRE OR INJURY TO PERSONS:

Turn off/unplug and allow to cool before replacing lamp/LED. Fixture gets HOT quickly! Contact only switch/plug when turning on. Do not touch hot lens, guard, or enclosure. Keep fixture away from materials that may burn. Do not operate the luminaire fitting with a missing or damaged shield. Do not touch the source at any time. Use a soft cloth or gloves. Oil from skin may cause damage.

SAVE THESE INSTRUCTIONS

IMPORTANT SAFETY INFORMATION - READ, FOLLOW, AND SAVE ALL SAFETY AND INSTALLATION INSTRUCTIONS

- Product must be installed by a qualified person in a manner consistent with its intended use and in compliance with the National Electrical Code, Canadian Electrical Code, and all Local and Provincial Codes.
- Follow product label information and instructions.
- Qualified Personnel with appropriate personal protective equipment must perform all servicing of this product.
- Before wiring to power supply and during servicing, turn off and lock out power at fuse or circuit breaker before service.
- The use of accessory equipment not recommended by the manufacturer or installed contrary to instructions may cause an unsafe condition. The use of damaged components may cause an unsafe condition and void product warranty.
- Do not block light emanating from product in whole or part, as this may cause an unsafe condition.
- Never operate the fixture with missing or damaged lens. Lens must be cleaned on regular basis.
- Entire fixture may become extremely hot. Do not touch hot lens or fixture body.
- Replace LED assembly only with correct wattage and type of power supply appropriate for LED assembly.
- All gaskets, o-rings and sealing surfaces must be kept clean during installation and service; failure to do this may cause an unsafe condition and void product warranty.

IMPORTANT LISTINGS AND CERTIFICATIONS

- Suitable for wet locations • Additionally suitable for mounting within 4 ft. of the ground

Lamp Installation or Re-Lamping if Required for PAR38 Halogen Lamp

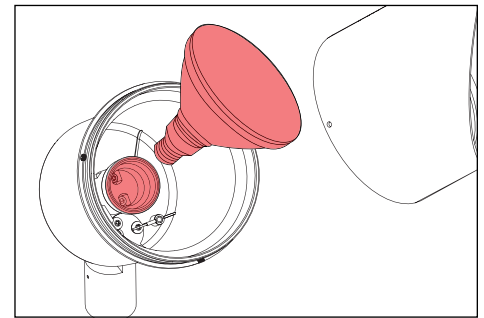
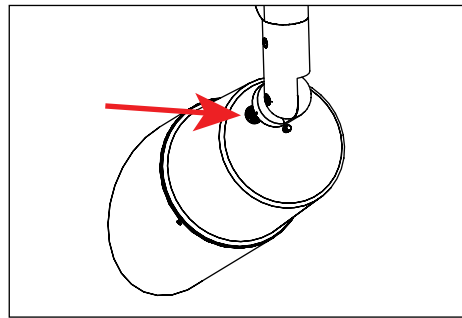
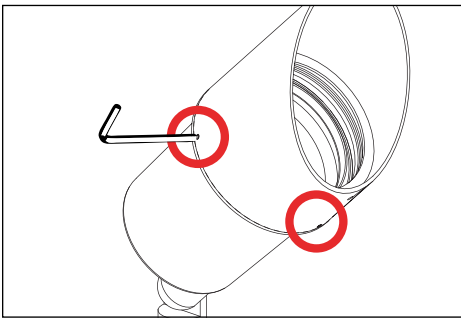

1. Loosen three (3) #10-32 stainless steel set screws on cap with a 5/32" allen wrench. Retain screws in cap.
 2. Press patented Anti-Condensation Valve (ACV™) to release vacuum created inside the fixture during normal use. The valve is spring-loaded, by depressing it, air is allowed to re-enter the chamber and the pressure is then equalized. When the air-pressure equalizes the cap will release from body to allow lamp service.
 2. Insert PAR38 halogen lamp into socket.
 3. Replace cap on fixture and tighten three (3) #10-32 stainless steel set screws with a 5/32" allen wrench.
- ⚠ **Do not exceed the maximum wattage listed on the fixture label before installing.**
- ⚠ **Warning: Do not over tighten set screw. Doing so will compromise o-ring seal and will void warranty.**

IMPORTANT SAFETY INFORMATION - READ, FOLLOW, AND SAVE THESE INSTALLATION INSTRUCTIONS

B-K LIGHTING

40429 Brickyard Drive • Madera, CA 93636 • USA
559.438.5800 • FAX 559.438.5900
www.bklighting.com • info@bklighting.com

RELEASE DATE
09/16/2025

REFERENCE NUMBER
INS-2147-00