

Standard Installation



Flammable



Warning



Low Voltage



Hot Surface

TOOLS NEEDED:



3/16" Allen Wrench



Waterproof Wire Connectors

INSTRUCTIONS PERTAINING TO A RISK OF FIRE, OR INJURY TO PERSONS IMPORTANT SAFETY INSTRUCTIONS

Lighted fixture is HOT!

WARNING - To reduce the risk of FIRE OR INJURY TO PERSONS:

Turn off/unplug and allow to cool before replacing lamp/LED. Fixture gets HOT quickly! Contact only switch/plug when turning on. Do not touch hot lens, guard, or enclosure. Keep fixture away from materials that may burn. Do not operate the luminaire fitting with a missing or damaged shield. Do not touch the source at any time. Use a soft cloth or gloves. Oil from skin may cause damage.

SAVE THESE INSTRUCTIONS

IMPORTANT SAFETY INFORMATION - READ, FOLLOW, AND SAVE ALL SAFETY AND INSTALLATION INSTRUCTIONS

- Product must be installed by a qualified person in a manner consistent with its intended use and in compliance with the National Electrical Code, Canadian Electrical Code, and all Local and Provincial Codes.
- Follow product label information and instructions.
- Qualified Personnel with appropriate personal protective equipment must perform all servicing of this product.
- Before wiring to power supply and during servicing, turn off and lock out power at fuse or circuit breaker before service.
- The use of accessory equipment not recommended by the manufacturer or installed contrary to instructions may cause an unsafe condition. The use of damaged components may cause an unsafe condition and void product warranty.
- Do not block light emanating from product in whole or part, as this may cause an unsafe condition.
- Never operate the fixture with missing or damaged lens. Lens must be cleaned on regular basis.
- Entire fixture may become extremely hot. Do not touch hot lens or fixture body.
- Replace LED assembly only with correct wattage and type of power supply appropriate for LED assembly.
- All gaskets, o-rings and sealing surfaces must be kept clean during installation and service; failure to do this may cause an unsafe condition and void product warranty.

IMPORTANT LISTINGS AND CERTIFICATIONS

- Suitable for wet locations

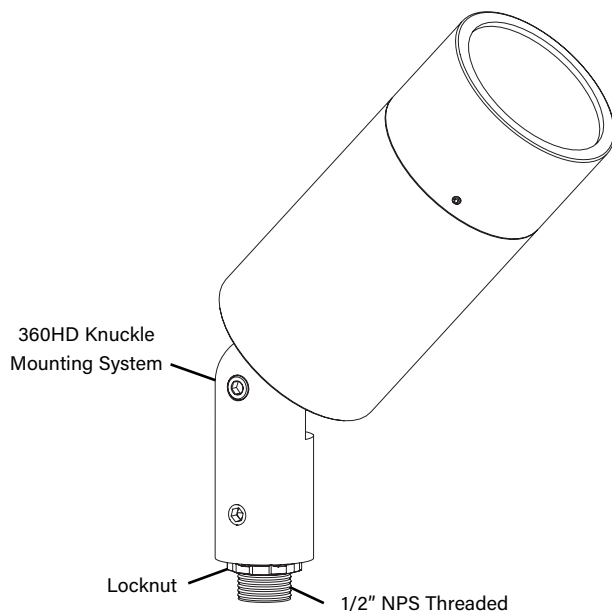

⚠ REMOTE WIRING

LED Driver

Remote driver installations require inter-connected wiring between the LED and driver (not included). Drivers have specific wiring requirements between these components. Driver manufacturers regularly recommend the following wiring details for such installations:

- Do not exceed 50 foot overall wiring distance using 12 gauge copper wire.

Failure to comply with specific wiring requirements will void product warranty.

⚠ DRIVER HOUSING REQUIRED

Please refer to specified remote driver housing documentation for detailed installation instructions.

REMOTE DRIVER HOUSINGS:

- HP2RM** - HP2 Remote Housing
- PM2RM** - Universal Power Module 2 Remote
- PM2DRM** - Universal Power Module 2 Dual Remote
- RM** - Remote Wall Mount
- DRM** - Dual Remote Wall Mount

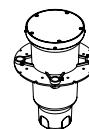

HP2RM

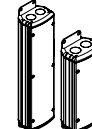

PM2RM & PM2DRM

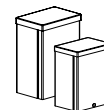

RM & DRM

IMPORTANT SAFETY INFORMATION - READ, FOLLOW, AND SAVE THESE INSTALLATION INSTRUCTIONS

B-K LIGHTING

40429 Brickyard Drive • Madera, CA 93636 • USA
559.438.5800 • FAX 559.438.5900
www.bklighting.com • info@bklighting.com

RELEASE DATE
02/05/2024

REFERENCE NUMBER
INS001113

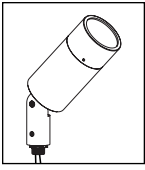

Fixture Installation

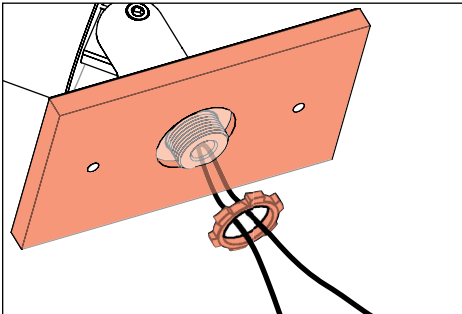

1. Mount knuckle onto suitable enclosure according to designed lighting plan.
2. Secure 1/2" NPS stem to mounting option. Secure with provided locknut if applicable.

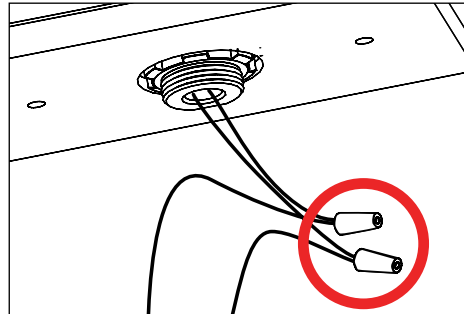

3. Make watertight connections from remote driver housing to LED source leads using waterproof wire connectors (not included). **See wiring diagram.**

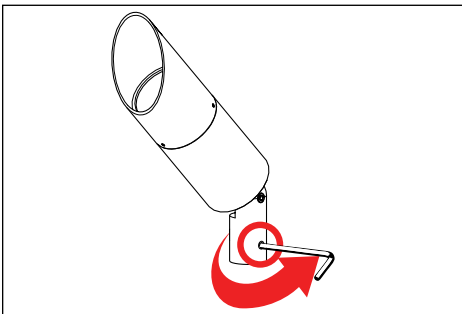
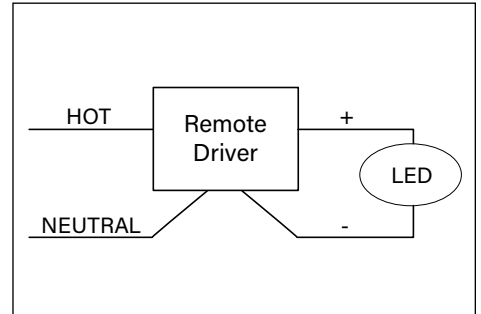

4. Use a 3/16" allen wrench to slightly loosen one (1) 3/8"-16 set screw on the knuckle for 360° aiming purpose.
5. Rotate fixture at base and aim fixture to desired horizontal location.

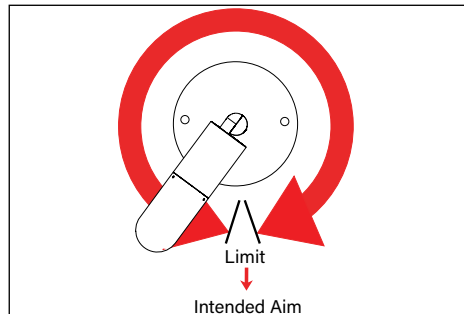

6. If the over-rotation protection pin is in the desired aiming position, do not force the fixture past the limit. Using a 3/16" allen wrench, slightly loosen both set screws in the knuckle, enough to move the fixture freely on both axes.

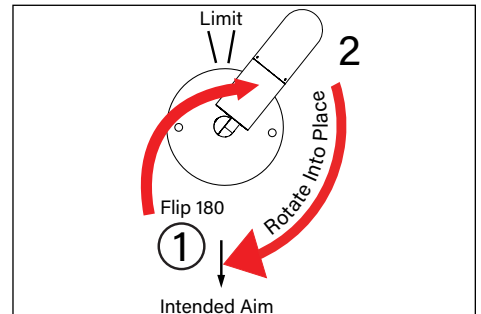

7. Flip the fixture 180 degrees over the knuckle. The rotational range limit will now be 180 degrees from the original position. Now rotate the fixture into the desired aiming position.
8. Secure aim by tightening one (1) 3/8"-16 set screw using a 3/16" allen wrench.

⚠ Rotating the cap may be necessary for proper weep hole and cutoff position

⚠ Warning: Do not over tighten cap set screws. Doing so will compromise o-ring seal and will void warranty.

**IMPORTANT SAFETY INFORMATION LISTED ON REVERSE
READ, FOLLOW, AND SAVE ALL SAFETY AND INSTALLATION INSTRUCTIONS**



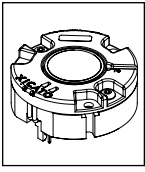

LED BOARD/OPTICS

CHIP ON BOARD TECHNOLOGY (x58-x63)

Standard Installation Replacement



TOOLS
NEEDED:

.050" & 5/64" Allen Wrench

INSTRUCTIONS PERTAINING TO A RISK OF FIRE, OR INJURY TO PERSONS IMPORTANT SAFETY INSTRUCTIONS

Lighted fixture is HOT!

**WARNING - To reduce the risk of
FIRE OR INJURY TO PERSONS:**

Turn off/unplug and allow to cool before replacing lamp/LED. Fixture gets HOT quickly! Contact only switch/plug when turning on. Do not touch hot lens, guard, or enclosure. Keep fixture away from materials that may burn. Do not operate the luminaire fitting with a missing or damaged shield. Do not touch the source at any time. Use a soft cloth or gloves. Oil from skin may cause damage.

SAVE THESE INSTRUCTIONS

IMPORTANT SAFETY INFORMATION - READ, FOLLOW, AND SAVE ALL SAFETY AND INSTALLATION INSTRUCTIONS

- Product must be installed by a qualified person in a manner consistent with its intended use and in compliance with the National Electrical Code, Canadian Electrical Code, and all Local and Provincial Codes.
- Follow product label information and instructions.
- Qualified Personnel with appropriate personal protective equipment must perform all servicing of this product.
- Before wiring to power supply and during servicing, turn off and lock out power at fuse or circuit breaker before service.
- The use of accessory equipment not recommended by the manufacturer or installed contrary to instructions may cause an unsafe condition. The use of damaged components may cause an unsafe condition and void product warranty.
- Do not block light emanating from product in whole or part, as this may cause an unsafe condition.
- Never operate the fixture with missing or damaged lens. Lens must be cleaned on regular basis.
- Entire fixture may become extremely hot. Do not touch hot lens or fixture body.
- Replace LED assembly only with correct wattage and type of power supply appropriate for LED assembly.
- All gaskets, o-rings and sealing surfaces must be kept clean during installation and service; failure to do this may cause an unsafe condition and void product warranty.

IMPORTANT LISTINGS AND CERTIFICATIONS

- Suitable for wet locations



This product is available with field replaceable components. Exclusive interchangeable modular LED components with quick disconnects simplifies upgrades and maintenance when necessary.

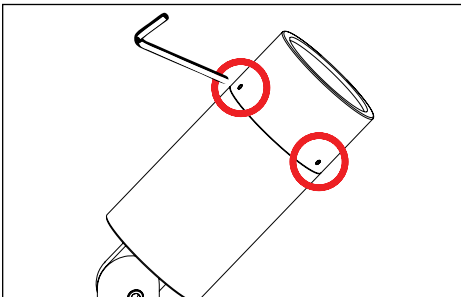

1. Use a 5/64" allen wrench to slightly loosen three (3) #8-32 stainless steel set screws to remove cap.

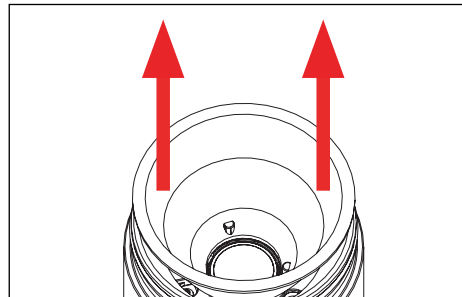

2. Remove optic by pulling gently and lift up.

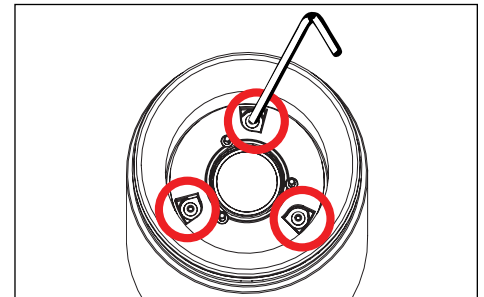

3. Use a .050" allen wrench to loosen three (3) set screws holding optic holder and LED module.

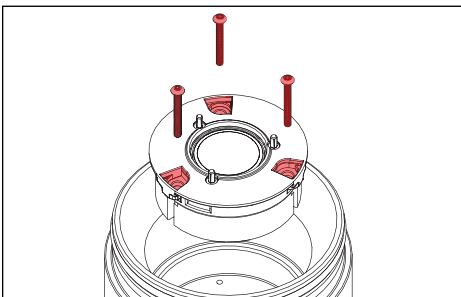

4. Gently lift LED module and disconnect from fixture. Install new LED module. Secure set screws through LED module and optic holder using a .050" allen wrench.

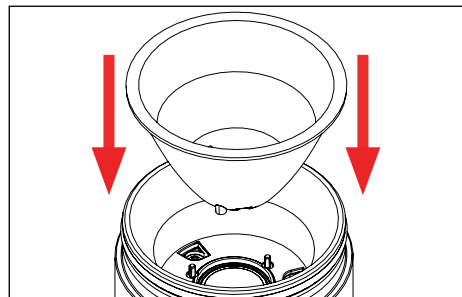

5. Replace optic by lining tabs with optic holder, then pressing down gently until secured into place.

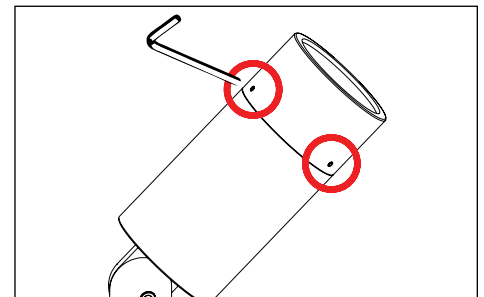

6. Place cap on fixture and tighten set screws until they are flush with the cap.

⚠ Do not pull on connector or wiring. Handle with care.

⚠ Warning: Do not over tighten set screws. Doing so will compromise o-ring seal and will void warranty. Cap should be able to rotate without force.

IMPORTANT SAFETY INFORMATION - READ, FOLLOW, AND SAVE THESE INSTALLATION INSTRUCTIONS

B-K LIGHTING

40429 Brickyard Drive • Madera, CA 93636 • USA
559.438.5800 • FAX 559.438.5900
www.bklighting.com • info@bklighting.com

RELEASE DATE
02/05/2024

REFERENCE NUMBER
INS000010

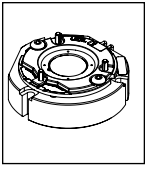

LED BOARD/OPTICS

CHIP ON BOARD TECHNOLOGY (x64-x66)

Standard Installation Replacement



Warning



Hot Surface

TOOLS
NEEDED:

.050" & 5/64" Allen Wrench

INSTRUCTIONS PERTAINING TO A RISK OF FIRE, OR INJURY TO PERSONS IMPORTANT SAFETY INSTRUCTIONS

Lighted fixture is HOT!

WARNING - To reduce the risk of FIRE OR INJURY TO PERSONS:

Turn off/unplug and allow to cool before replacing lamp/LED. Fixture gets HOT quickly! Contact only switch/plug when turning on. Do not touch hot lens, guard, or enclosure. Keep fixture away from materials that may burn. Do not operate the luminaire fitting with a missing or damaged shield. Do not touch the source at any time. Use a soft cloth or gloves. Oil from skin may cause damage.

SAVE THESE INSTRUCTIONS

IMPORTANT SAFETY INFORMATION - READ, FOLLOW, AND SAVE ALL SAFETY AND INSTALLATION INSTRUCTIONS

- Product must be installed by a qualified person in a manner consistent with its intended use and in compliance with the National Electrical Code, Canadian Electrical Code, and all Local and Provincial Codes.
- Follow product label information and instructions.
- Qualified Personnel with appropriate personal protective equipment must perform all servicing of this product.
- Before wiring to power supply and during servicing, turn off and lock out power at fuse or circuit breaker before service.
- The use of accessory equipment not recommended by the manufacturer or installed contrary to instructions may cause an unsafe condition. The use of damaged components may cause an unsafe condition and void product warranty.
- Do not block light emanating from product in whole or part, as this may cause an unsafe condition.
- Never operate the fixture with missing or damaged lens. Lens must be cleaned on regular basis.
- Entire fixture may become extremely hot. Do not touch hot lens or fixture body.
- Replace LED assembly only with correct wattage and type of power supply appropriate for LED assembly.
- All gaskets, o-rings and sealing surfaces must be kept clean during installation and service; failure to do this may cause an unsafe condition and void product warranty.

IMPORTANT LISTINGS AND CERTIFICATIONS

- Suitable for wet locations



This product is available with field replaceable components. Exclusive interchangeable modular LED components with quick disconnects simplifies upgrades and maintenance when necessary.

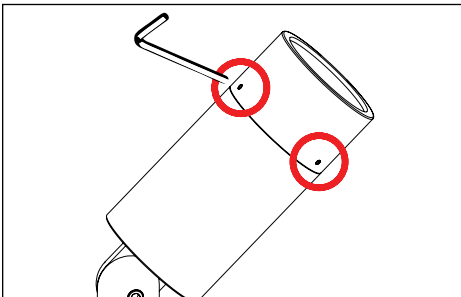

1. Use a 5/64" allen wrench to slightly loosen three (3) #8-32 stainless steel set screws to remove cap.

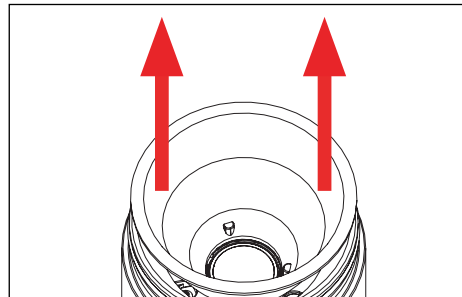

2. Remove optic by pulling gently and lift up.

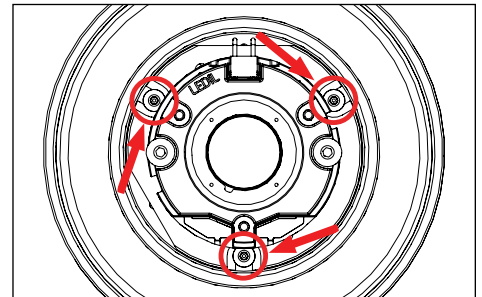

3. Use a .050" allen wrench to loosen three (3) set screws holding LED module. Gently lift from fixture.

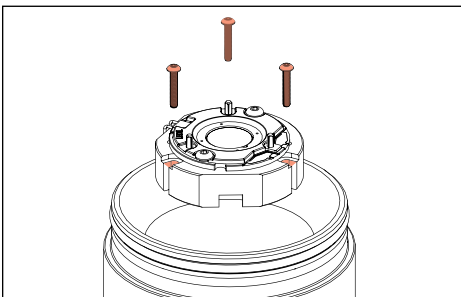

4. Gently lift LED module and disconnect from fixture. Install new LED module. Secure set screws using a .050" allen wrench.

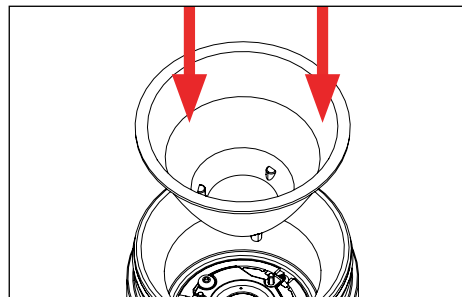

5. Replace optic by lining notches with optic holder, then pressing down gently until secured into place.

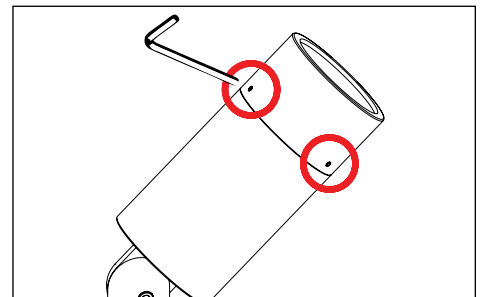

6. Place cap on fixture and tighten set screws until they are flush with the cap.

⚠ Do not pull on connector or wiring. Handle with care.

⚠ Warning: Do not over tighten set screws. Doing so will compromise o-ring seal and will void warranty. Cap should be able to rotate without force.

IMPORTANT SAFETY INFORMATION - READ, FOLLOW, AND SAVE THESE INSTALLATION INSTRUCTIONS

B-K LIGHTING

40429 Brickyard Drive • Madera, CA 93636 • USA
559.438.5800 • FAX 559.438.5900
www.bklighting.com • info@bklighting.com

RELEASE DATE
02/05/2024

REFERENCE NUMBER
INS000010