

NITE STAR WALL MOUNT SINGLE/TWIN - POWER CANOPY - LED/MR16 LOW VOLTAGE

Installation Instruction



Flammable



Warning





High Voltage



Hot Surface

TOOLS NEEDED:

-  5/32" & 5/64" Allen Wrench
-  Waterproof Wire Connectors
-  Mounting Hardware

INSTRUCTIONS PERTAINING TO A RISK OF FIRE, OR INJURY TO PERSONS IMPORTANT SAFETY INSTRUCTIONS

Lighted fixture is HOT!

WARNING - To reduce the risk of FIRE OR INJURY TO PERSONS:

Turn off/unplug and allow to cool before replacing lamp/LED. Fixture gets HOT quickly! Contact only switch/plug when turning on. Do not touch hot lens, guard, or enclosure. Keep fixture away from materials that may burn. Do not operate the luminaire fitting with a missing or damaged shield. Do not touch the source at any time. Use a soft cloth or gloves. Oil from skin may cause damage.

SAVE THESE INSTRUCTIONS

IMPORTANT SAFETY INFORMATION - READ, FOLLOW, AND SAVE ALL SAFETY AND INSTALLATION INSTRUCTIONS

- Product must be installed by a qualified person in a manner consistent with its intended use and in compliance with the National Electrical Code, Canadian Electrical Code, and all Local and Provincial Codes.
- Follow product label information and instructions.
- Qualified Personnel with appropriate personal protective equipment must perform all servicing of this product.
- Before wiring to power supply and during servicing, turn off and lock out power at fuse or circuit breaker before service.
- The use of accessory equipment not recommended by the manufacturer or installed contrary to instructions may cause an unsafe condition. The use of damaged components may cause an unsafe condition and void product warranty.
- Do not block light emanating from product in whole or part, as this may cause an unsafe condition.
- Never operate the fixture with missing or damaged lens. Lens must be cleaned on regular basis.
- Entire fixture may become extremely hot. Do not touch hot lens or fixture body.
- Replace LED assembly only with correct wattage and type of power supply appropriate for LED assembly.
- All gaskets, o-rings and sealing surfaces must be kept clean during installation and service; failure to do this may cause an unsafe condition and void product warranty.

IMPORTANT LISTINGS AND CERTIFICATIONS

- Suitable for wet locations

This set of instructions works for:

- NS-WM-A - Nite Star Wall Mount Style "A"
- NS-WM-B - Nite Star Wall Mount Style "B"
- NS-WM-C - Nite Star Wall Mount Style "C"
- NS-WM-D - Nite Star Wall Mount Style "D"
- NS-WM-L - Nite Star Wall Mount Style "L"
- NS-WM-F - Nite Star Wall Mount Style "F"
- NS-WM-G - Nite Star Wall Mount Style "G"

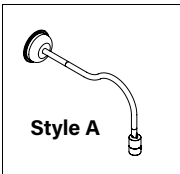
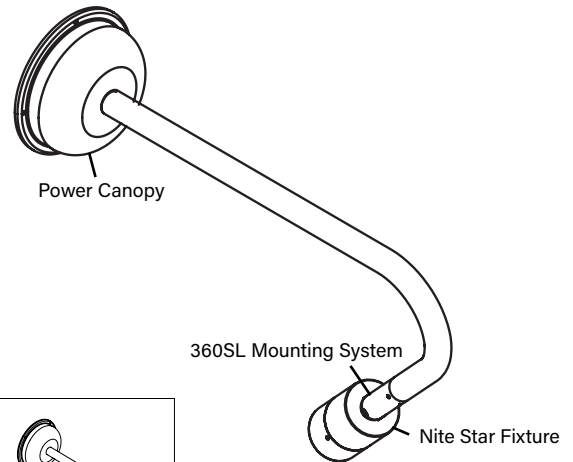

Style A

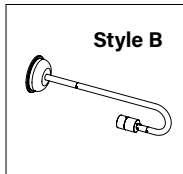

Style B

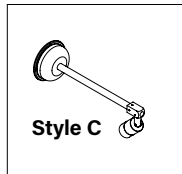

Style C

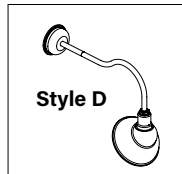

Style D

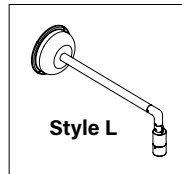

Style L

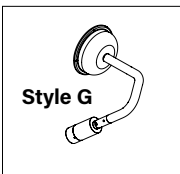

Style G

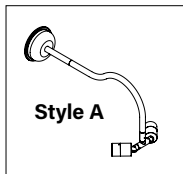

Style A

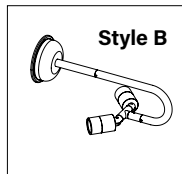

Style B

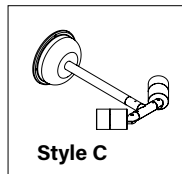

Style C

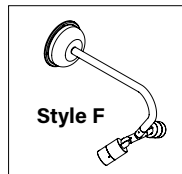

Style F

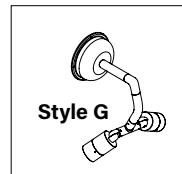

Style G

IMPORTANT SAFETY INFORMATION - READ, FOLLOW, AND SAVE THESE INSTALLATION INSTRUCTIONS

B-K LIGHTING

40429 Brickyard Drive • Madera, CA 93636 • USA
559.438.5800 • FAX 559.438.5900
www.bklighting.com • info@bklighting.com

RELEASE DATE
04/02/2026

REFERENCE NUMBER
INS-2264-00

THIS DOCUMENT CONTAINS PROPRIETARY INFORMATION OF B-K LIGHTING, INC. AND ITS RECEIPT OR POSSESSION DOES NOT CONVEY ANY RIGHTS TO REPRODUCE, DISCLOSE ITS CONTENTS, OR TO MANUFACTURE, USE OR SELL ANYTHING IT MAY DESCRIBE. REPRODUCTION, DISCLOSURE OR USE WITHOUT SPECIFIC WRITTEN AUTHORIZATION OF B-K LIGHTING, INC. IS STRICTLY FORBIDDEN.

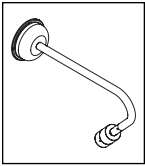

Installation Instruction

Phase 1 - Rough In Installation of Back box

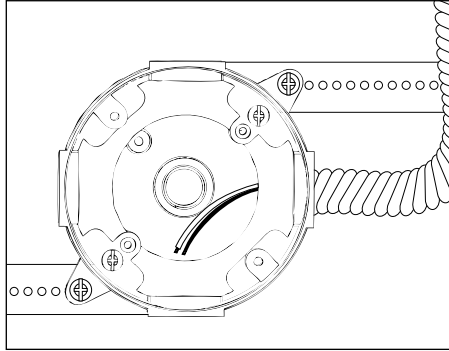

Additional Info

- Please follow National and Local electrical codes for your area.
- Suitable for through wire.
- Suitable for installation into combustible materials.
- Rated for 90° C.
- Junction box, universal mounting ring screws, box mounting hardware and gaskets (not included).

⚠ Nite Star Bollard Style D (NS-BO-D) shade must be installed facing downwards. Installations where shade is facing upwards will VOID WARRANTY.

1. Install conduit (not included) to be used with this product.
2. Install junction box so that front face is flush with finished wall. Seal building envelope as per NEC.
3. Connect box to conduit and pull wires for connections (**See wiring diagram**).

Phase 2 - Finish Installation of Fixture

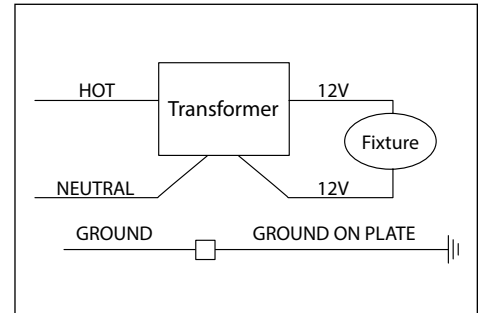
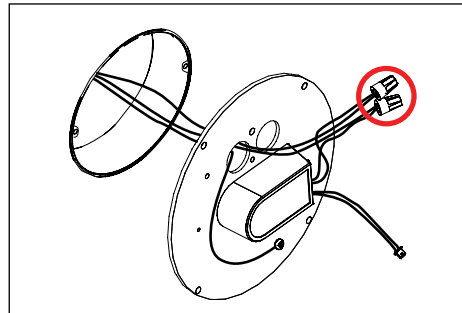
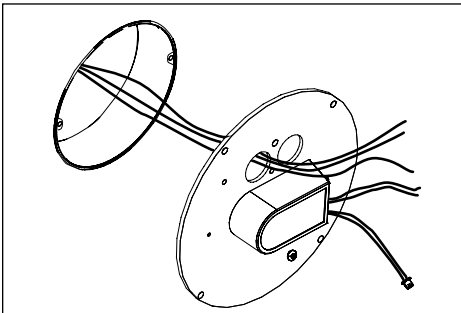

1. Remove wire entrance knockouts as needed on wall plate. Pull primary branch circuit through knockout(s). Attach wall plate to junction box using appropriate hardware.
2. Ground primary branch circuit to wall plate per NEC. Make watertight connections from transformer to primary branch circuit using waterproof wire connectors. **See wiring diagram.**

WIRING DIAGRAM

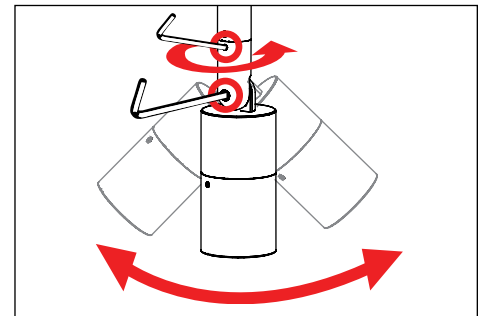
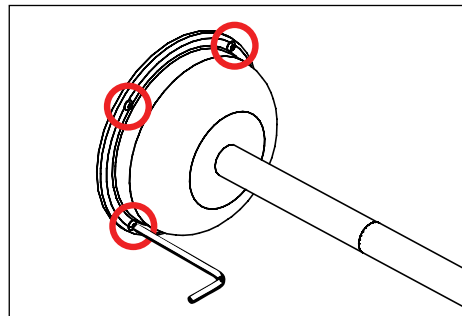
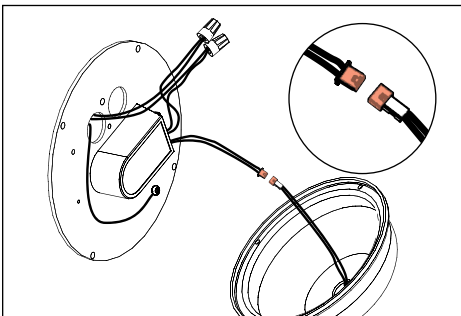

3. Connect fixture to transformer with provided quick disconnect.
4. Mount canopy to wall plate using four (4) #8-32 stainless steel button head screws with a 5/64" allen wrench. **Seal building envelope as per NEC. Do not overtighten.**
5. Use a 5/32" allen wrench to loosen #10-32 stainless steel black oxide socket head cap screw at the knuckle. Aim fixture to desired vertical location. Tighten to secure aiming position.
6. **Optional 360SL:** Use a 5/64" allen wrench to loosen stainless steel set screw on the 360SL rotational mounting system and rotate to desired horizontal location. Tighten to secure aiming position.

⚠ Nite Star Bollard Style D (NS-BO-D) shade must be installed facing downwards.

**IMPORTANT SAFETY INFORMATION LISTED ON REVERSE
READ, FOLLOW, AND SAVE ALL SAFETY AND INSTALLATION INSTRUCTIONS**



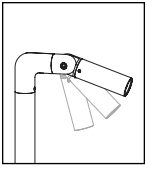

Standard Adjustment



Flammable



Warning



Hot Surface

TOOLS
NEEDED:

5/32" & 5/64" Allen Wrench

INSTRUCTIONS PERTAINING TO A RISK OF FIRE, OR INJURY TO PERSONS IMPORTANT SAFETY INSTRUCTIONS

Lighted fixture is HOT!

WARNING - To reduce the risk of FIRE OR INJURY TO PERSONS:

Turn off/unplug and allow to cool before replacing lamp/LED. Fixture gets HOT quickly! Contact only switch/plug when turning on. Do not touch hot lens, guard, or enclosure. Keep fixture away from materials that may burn. Do not operate the luminaire fitting with a missing or damaged shield. Do not touch the source at any time. Use a soft cloth or gloves. Oil from skin may cause damage.

SAVE THESE INSTRUCTIONS

IMPORTANT SAFETY INFORMATION - READ, FOLLOW, AND SAVE ALL SAFETY AND INSTALLATION INSTRUCTIONS

- Product must be installed by a qualified person in a manner consistent with its intended use and in compliance with the National Electrical Code, Canadian Electrical Code, and all Local and Provincial Codes.
- Follow product label information and instructions.
- Qualified Personnel with appropriate personal protective equipment must perform all servicing of this product.
- Before wiring to power supply and during servicing, turn off and lock out power at fuse or circuit breaker before service.
- The use of accessory equipment not recommended by the manufacturer or installed contrary to instructions may cause an unsafe condition. The use of damaged components may cause an unsafe condition and void product warranty.
- Do not block light emanating from product in whole or part, as this may cause an unsafe condition.
- Never operate the fixture with missing or damaged lens. Lens must be cleaned on regular basis.
- Entire fixture may become extremely hot. Do not touch hot lens or fixture body.
- Replace LED assembly only with correct wattage and type of power supply appropriate for LED assembly.
- All gaskets, o-rings and sealing surfaces must be kept clean during installation and service; failure to do this may cause an unsafe condition and void product warranty.

IMPORTANT LISTINGS AND CERTIFICATIONS

- Suitable for wet locations • Additionally suitable for mounting within 4 ft. of the ground

L.O.C.K. Knuckle - (Locking 'O' Ring Compression Knuckle)

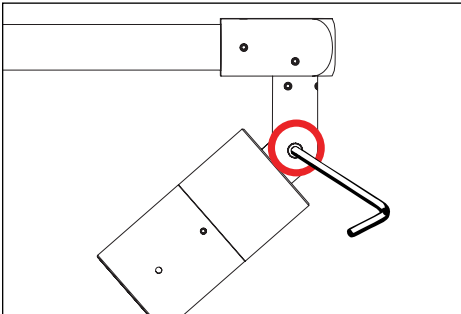

1. Use a 5/32" allen wrench to slightly loosen #10-32 stainless steel set screw on the stem for 180° aiming purpose.

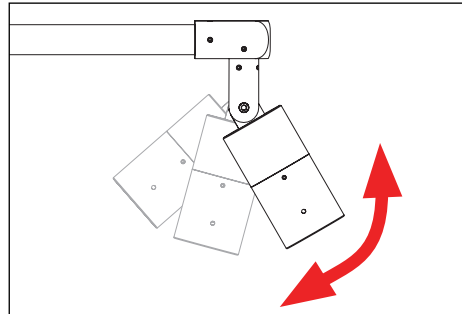

2. Aim fixture to desired angle.

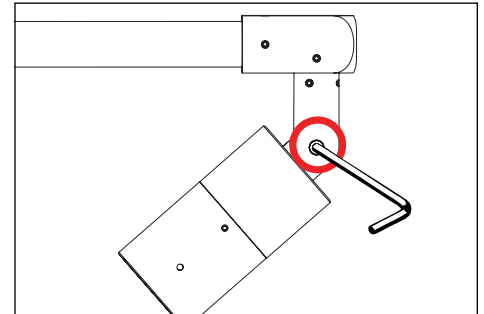

3. Tighten #10-32 stainless steel set screw using a 5/32" allen wrench to secure aiming position.

⚠ Warning: Do not over tighten set screw. Doing so will compromise o-ring seal and will void warranty.

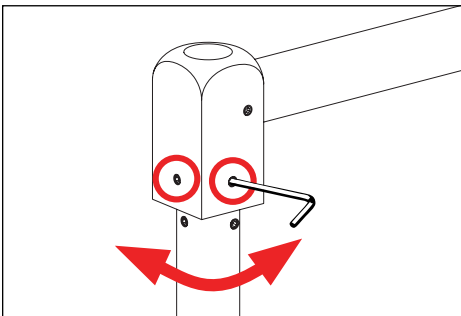

4. To adjust stem horizontally, loosen two (2) #8-32 screws at base of stem cap using a 5/64" allen wrench. Adjust as needed, then secure.

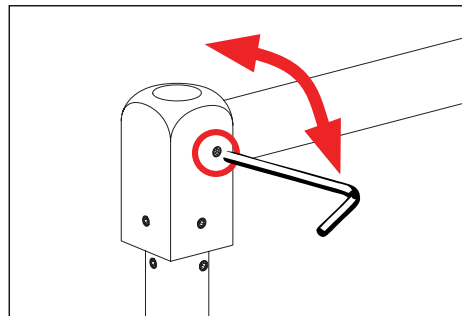

5. To adjust stem, loosen #8-32 screw with a 5/64" allen wrench at stem cap. Adjust as needed, then secure.

IMPORTANT SAFETY INFORMATION - READ, FOLLOW, AND SAVE THESE INSTALLATION INSTRUCTIONS

B-K LIGHTING

40429 Brickyard Drive • Madera, CA 93636 • USA
559.438.5800 • FAX 559.438.5900
www.bklighting.com • info@bklighting.com

RELEASE DATE
04/02/2026

REFERENCE NUMBER
INS-2164-01

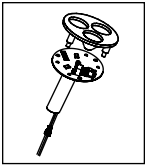

LED BOARD & OPTICS

2 1/4" BODY SIZE

Standard Installation/Replacement



Flammable



Warning



Low Voltage



Hot Surface

TOOLS NEEDED:



5/64" & 9/64" Allen Wrench



Small Flat Head Screwdriver

INSTRUCTIONS PERTAINING TO A RISK OF FIRE, OR INJURY TO PERSONS IMPORTANT SAFETY INSTRUCTIONS

Lighted fixture is HOT!

WARNING - To reduce the risk of FIRE OR INJURY TO PERSONS:

Turn off/unplug and allow to cool before replacing lamp/LED. Fixture gets HOT quickly! Contact only switch/plug when turning on. Do not touch hot lens, guard, or enclosure. Keep fixture away from materials that may burn. Do not operate the luminaire fitting with a missing or damaged shield. Do not touch the source at any time. Use a soft cloth or gloves. Oil from skin may cause damage.

SAVE THESE INSTRUCTIONS

IMPORTANT SAFETY INFORMATION - READ, FOLLOW, AND SAVE ALL SAFETY AND INSTALLATION INSTRUCTIONS

- Product must be installed by a qualified person in a manner consistent with its intended use and in compliance with the National Electrical Code, Canadian Electrical Code, and all Local and Provincial Codes.
- Follow product label information and instructions.
- Qualified Personnel with appropriate personal protective equipment must perform all servicing of this product.
- Before wiring to power supply and during servicing, turn off and lock out power at fuse or circuit breaker before service.
- The use of accessory equipment not recommended by the manufacturer or installed contrary to instructions may cause an unsafe condition. The use of damaged components may cause an unsafe condition and void product warranty.
- Do not block light emanating from product in whole or part, as this may cause an unsafe condition.
- Never operate the fixture with missing or damaged lens. Lens must be cleaned on regular basis.
- Entire fixture may become extremely hot. Do not touch hot lens or fixture body.
- Replace LED assembly only with correct wattage and type of power supply appropriate for LED assembly.
- All gaskets, o-rings and sealing surfaces must be kept clean during installation and service; failure to do this may cause an unsafe condition and void product warranty.

IMPORTANT LISTINGS AND CERTIFICATIONS



This product is available with Adjust-e-Lume (Patent Pend.) for Dynamic Lumen Output Control

Warning! The light output of this product may be dynamically adjusted as desired to raise and lower light levels. Please ensure the fixture is set to the appropriate light level desired during installation.

Replacing LED Board/Driver and Optics

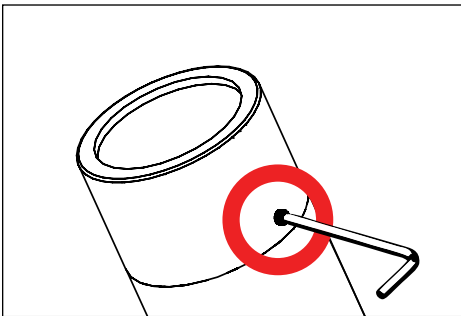

1. Use a 5/64" allen wrench to loosen #8-32 stainless set screw and remove cap.



2. Space three fingers evenly around the optic and gently rock optic to remove.



3. Use a 5/64" allen wrench to remove two (2) #2-56 socket head cap screws on LED board, grasp LED board and gently pull up to expose quick disconnect.

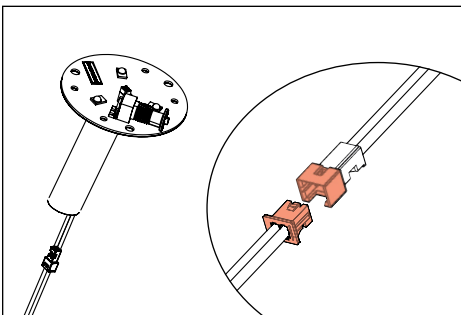

4. Disengage LED board and driver assembly. Replace with new board and driver assembly.

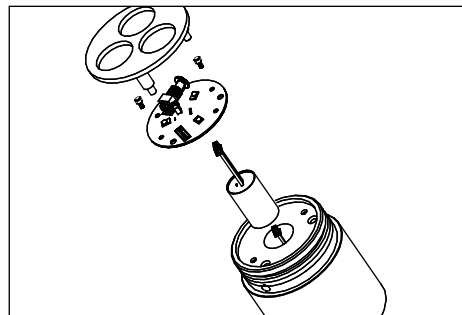

5. Reverse install LED board and driver by carefully engaging quick disconnects and inserting into fixture body. Secure LED board in place with stainless steel screws. Snap optics in place.

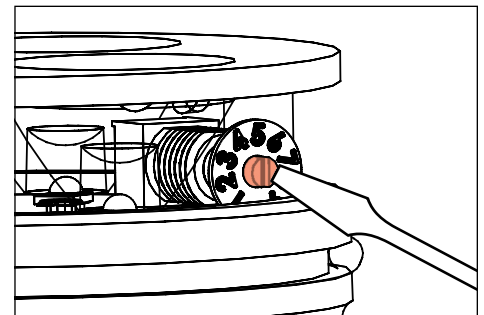

6. With flat head screwdriver rotate dial to desired lumen output.

IMPORTANT SAFETY INFORMATION - READ, FOLLOW, AND SAVE THESE INSTALLATION INSTRUCTIONS

B-K LIGHTING

40429 Brickyard Drive • Madera, CA 93636 • USA
559.438.5800 • FAX 559.438.5900
www.bklighting.com • info@bklighting.com

RELEASE DATE
04/02/2026

REFERENCE NUMBER
INS000001

LED BOARD & OPTICS

2 1/4" BODY SIZE

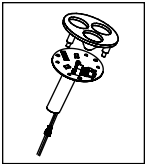

Standard Installation/Replacement

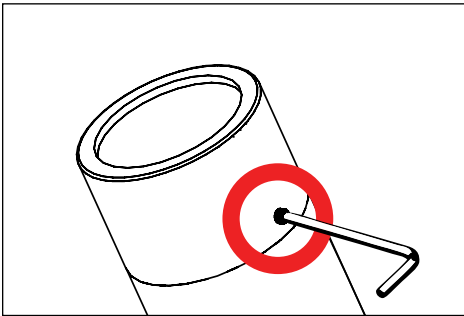

7. Re-install cap onto fixture. Secure by tightening three (3) #8-32 set screws using a 5/64" allen wrench. Top of set screws should sit flush with cap.

⚠ Warning: Do not over tighten set screws. Cap should be able to rotate without using force. Over tightening set screws will compromise o-ring seal and will void warranty.

Change Lumen Output

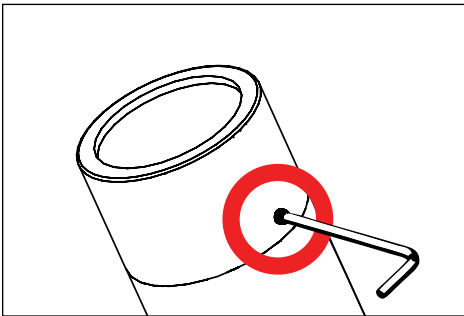

1. Use a 5/64" allen wrench to loosen #8-32 stainless set screw and remove cap.

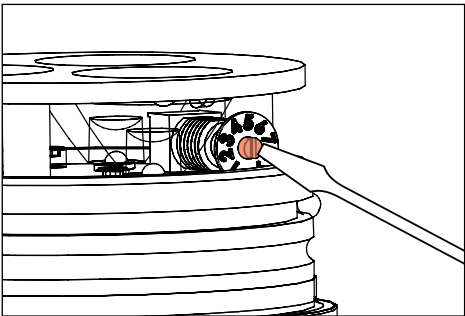

2. With flat head screwdriver rotate dial to desired lumen output.

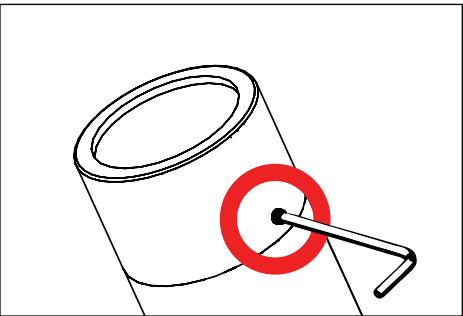

3. Re-install cap onto fixture. Secure by tightening three (3) #8-32 set screws using a 5/64" allen wrench. Top of set screws should sit flush with cap.

⚠ Warning: Do not over tighten set screws. Cap should be able to rotate without using force. Over tightening set screws will compromise o-ring seal and will void warranty.

**IMPORTANT SAFETY INFORMATION LISTED ON REVERSE
READ, FOLLOW, AND SAVE ALL SAFETY AND INSTALLATION INSTRUCTIONS**



B-K LIGHTING

40429 Brickyard Drive • Madera, CA 93636 • USA
559.438.5800 • FAX 559.438.5900
www.bklighting.com • info@bklighting.com

RELEASE DATE
04/02/2026

REFERENCE NUMBER
INS000001

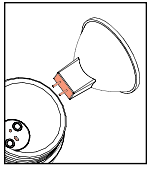

MR16 BOARD & OPTICS

2 1/4" BODY SIZE

Standard Installation/Replacement

Replacing MR16 Low Voltage Lamp

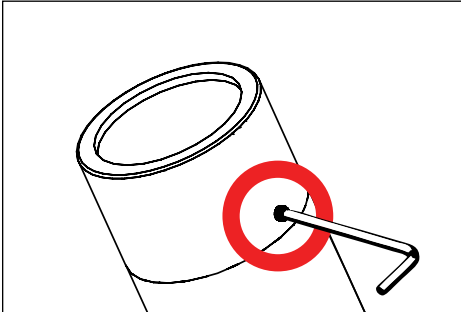

1. Use a 5/64" allen wrench to loosen #8-32 stainless set screw(s) and remove cap.

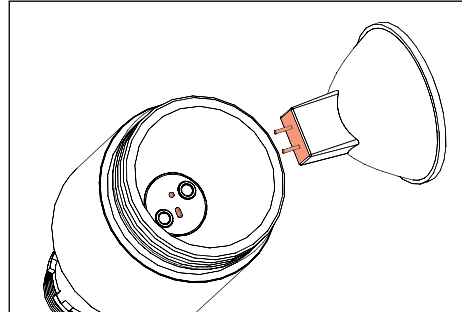

2. Firmly insert lamp pins into socket to make connection. Rocking motion may be required.

⚠ Do not exceed the maximum wattage listed on the fixture label before installing.

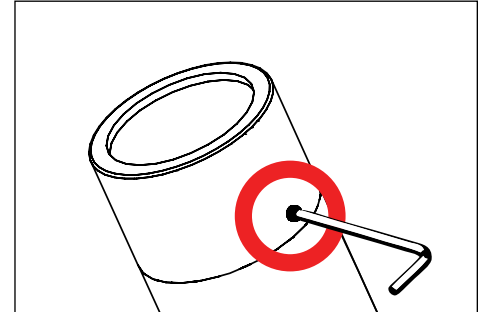

3. Re-install cap onto fixture. Secure by tightening three (3) #8-32 set screws using a 5/64" allen wrench. Top of set screws should sit flush with cap.

⚠ Warning: Do not over tighten set screws. Cap should be able to rotate without using force. Over tightening set screws will compromise o-ring seal and will void warranty.

**IMPORTANT SAFETY INFORMATION LISTED ON REVERSE
READ, FOLLOW, AND SAVE ALL SAFETY AND INSTALLATION INSTRUCTIONS**



B-K LIGHTING

40429 Brickyard Drive • Madera, CA 93636 • USA
559.438.5800 • FAX 559.438.5900
www.bklighting.com • info@bklighting.com

RELEASE DATE
04/02/2026

REFERENCE NUMBER
INS000001