

NITE STAR WALL MOUNT SINGLE/TWIN - CANOPY - LED/MR16 LOW VOLTAGE

Installation Instruction



Flammable



Warning



Low Voltage



Hot Surface

TOOLS NEEDED:



1/8", 5/32", & 5/64" Allen Wrench



Waterproof Wire Connectors

INSTRUCTIONS PERTAINING TO A RISK OF FIRE, OR INJURY TO PERSONS IMPORTANT SAFETY INSTRUCTIONS

Lighted fixture is HOT!

WARNING - To reduce the risk of FIRE OR INJURY TO PERSONS:

Turn off/unplug and allow to cool before replacing lamp/LED. Fixture gets HOT quickly! Contact only switch/plug when turning on. Do not touch hot lens, guard, or enclosure. Keep fixture away from materials that may burn. Do not operate the luminaire fitting with a missing or damaged shield. Do not touch the source at any time. Use a soft cloth or gloves. Oil from skin may cause damage.

SAVE THESE INSTRUCTIONS

IMPORTANT SAFETY INFORMATION - READ, FOLLOW, AND SAVE ALL SAFETY AND INSTALLATION INSTRUCTIONS

- Product must be installed by a qualified person in a manner consistent with its intended use and in compliance with the National Electrical Code, Canadian Electrical Code, and all Local and Provincial Codes.
- Follow product label information and instructions.
- Qualified Personnel with appropriate personal protective equipment must perform all servicing of this product.
- Before wiring to power supply and during servicing, turn off and lock out power at fuse or circuit breaker before service.
- The use of accessory equipment not recommended by the manufacturer or installed contrary to instructions may cause an unsafe condition. The use of damaged components may cause an unsafe condition and void product warranty.
- Do not block light emanating from product in whole or part, as this may cause an unsafe condition.
- Never operate the fixture with missing or damaged lens. Lens must be cleaned on regular basis.
- Entire fixture may become extremely hot. Do not touch hot lens or fixture body.
- Replace LED assembly only with correct wattage and type of power supply appropriate for LED assembly.
- All gaskets, o-rings and sealing surfaces must be kept clean during installation and service; failure to do this may cause an unsafe condition and void product warranty.

IMPORTANT LISTINGS AND CERTIFICATIONS

- Suitable for wet locations

Please refer to the low voltage design guide at "<https://www.bklighting.com/resources/>" before installation for proper wire selection.

This set of instructions works for:

- NS-WM-A - Nite Star Wall Mount Style "A"
- NS-WM-B - Nite Star Wall Mount Style "B"
- NS-WM-C - Nite Star Wall Mount Style "C"
- NS-WM-D - Nite Star Wall Mount Style "D"
- NS-WM-L - Nite Star Wall Mount Style "L"
- NS-WM-F - Nite Star Wall Mount Style "F"
- NS-WM-G - Nite Star Wall Mount Style "G"

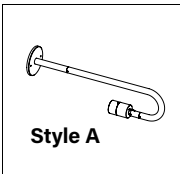
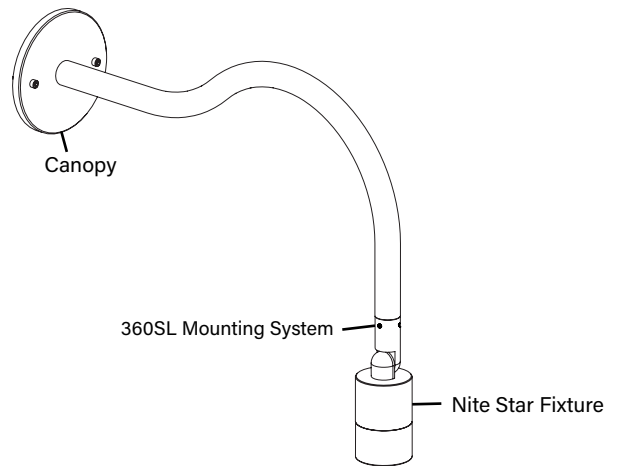

Style A

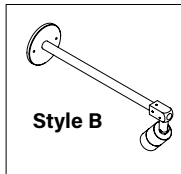

Style B

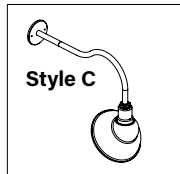

Style C

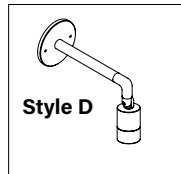

Style D

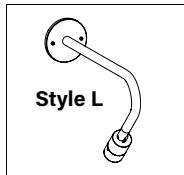

Style L

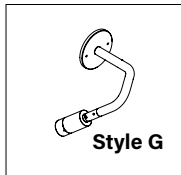

Style G

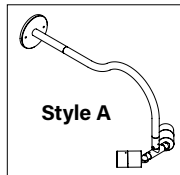

Style A

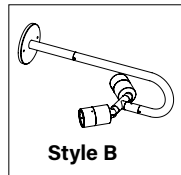

Style B

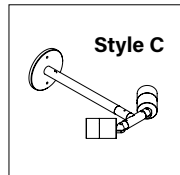

Style C

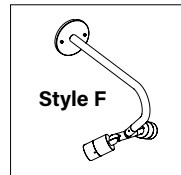

Style F

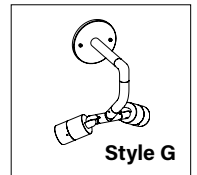

Style G

IMPORTANT SAFETY INFORMATION - READ, FOLLOW, AND SAVE THESE INSTALLATION INSTRUCTIONS

B-K LIGHTING

40429 Brickyard Drive • Madera, CA 93636 • USA
559.438.5800 • FAX 559.438.5900
www.bklighting.com • info@bklighting.com

RELEASE DATE
03/16/2026

REFERENCE NUMBER
INS-2264-00

THIS DOCUMENT CONTAINS PROPRIETARY INFORMATION OF B-K LIGHTING, INC. AND ITS RECEIPT OR POSSESSION DOES NOT CONVEY ANY RIGHTS TO REPRODUCE, DISCLOSE ITS CONTENTS, OR TO MANUFACTURE, USE OR SELL ANYTHING IT MAY DESCRIBE. REPRODUCTION, DISCLOSURE OR USE WITHOUT SPECIFIC WRITTEN AUTHORIZATION OF B-K LIGHTING, INC. IS STRICTLY FORBIDDEN.

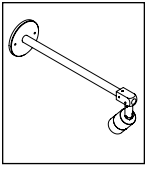

Installation Instruction

NITE STAR

WALL MOUNT SINGLE/TWIN - CANOPY - LED/MR16 LOW VOLTAGE

Phase 1 - Rough In

Installation of Back box

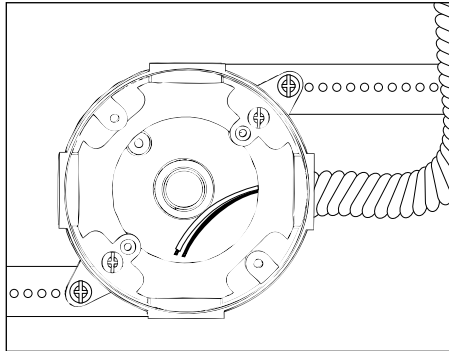

Additional Info

- Please follow National and Local electrical codes for your area.
- Suitable for through wire.
- Suitable for installation into combustible materials.
- Rated for 90° C.
- Junction box, universal mounting ring screws, box mounting hardware and gaskets (not included).

⚠ Nite Star Bollard Style D (NS-BO-D) shade must be installed facing downwards. Installations where shade is facing upwards will VOID WARRANTY.

1. Install conduit (not included) to be used with this product.
2. Install junction box so that front face is flush with finished wall. Seal building envelope as per NEC.
3. Connect box to conduit and pull wires for connections (**See wiring diagram**).

Phase 2 - Finish Installation of Fixture

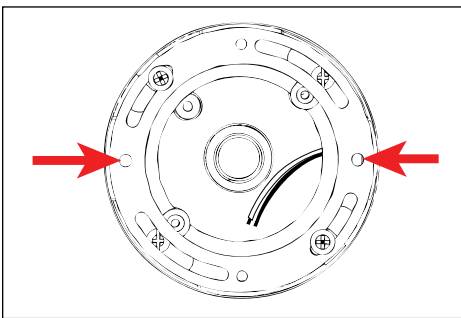

1. Install universal mounting ring (included with fixture) with #10-24 screws using a 1/8" allen wrench onto back box. Align fixture mounting holes to final mounting position.

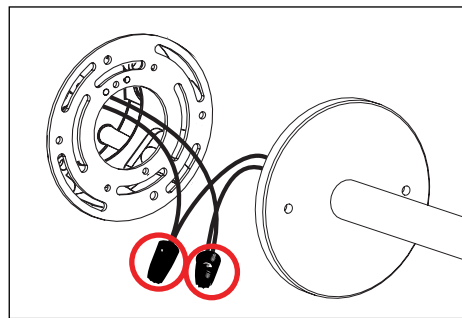

2. Make watertight connections from remote transformer to fixture leads using waterproof wire connectors. **See wiring diagram.**

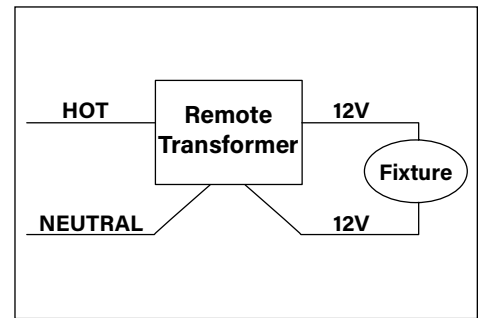

WIRING DIAGRAM

⚠ LED - For use with 12VAC LED remote transformer or magnetic transformers only. B-K Lighting cannot guarantee performance with third party manufacturers' transformers.

⚠ Low Voltage - For use with 12VAC remote transformer.

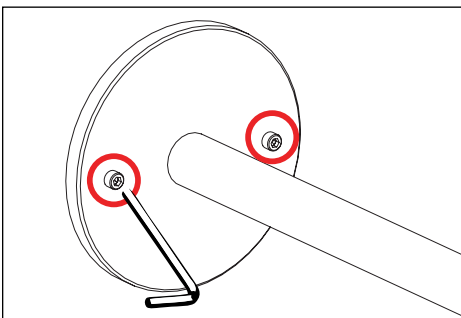

3. Mount canopy to junction box with universal mounting ring using two (2) #10-24 stainless steel black oxide screws with a 1/8" allen wrench. **Seal building envelope as per NEC. Do not overtighten.**

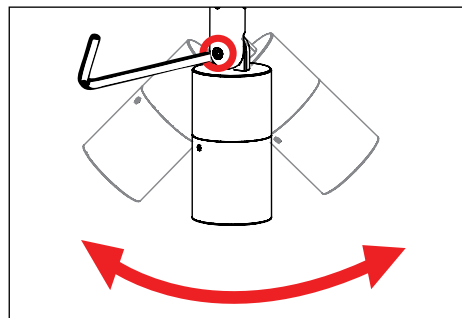

4. Use a 5/32" allen wrench to loosen #10-32 stainless steel black oxide socket head cap screw at the knuckle. Aim fixture to desired vertical location. Tighten to secure aiming position.

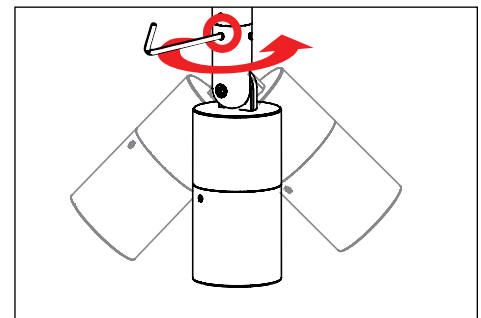

5. **Optional 360SL:** Use a 5/64" allen wrench to loosen stainless steel set screw on the 360SL rotational mounting system and rotate to desired horizontal location. Tighten to secure aiming position.

⚠ Nite Star Bollard Style D (NS-BO-D) shade must be installed facing downwards.

**IMPORTANT SAFETY INFORMATION LISTED ON REVERSE
READ, FOLLOW, AND SAVE ALL SAFETY AND INSTALLATION INSTRUCTIONS**



B-K LIGHTING

40429 Brickyard Drive • Madera, CA 93636 • USA
559.438.5800 • FAX 559.438.5900
www.bklighting.com • info@bklighting.com

RELEASE DATE
03/16/2026

REFERENCE NUMBER
INS-2264-00

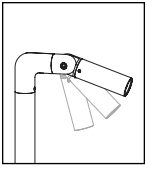

Standard Adjustment



Flammable



Warning



Hot Surface

TOOLS
NEEDED:

5/32" & 5/64" Allen Wrench

INSTRUCTIONS PERTAINING TO A RISK OF FIRE, OR INJURY TO PERSONS IMPORTANT SAFETY INSTRUCTIONS

Lighted fixture is HOT!

WARNING - To reduce the risk of FIRE OR INJURY TO PERSONS:

Turn off/unplug and allow to cool before replacing lamp/LED. Fixture gets HOT quickly! Contact only switch/plug when turning on. Do not touch hot lens, guard, or enclosure. Keep fixture away from materials that may burn. Do not operate the luminaire fitting with a missing or damaged shield. Do not touch the source at any time. Use a soft cloth or gloves. Oil from skin may cause damage.

SAVE THESE INSTRUCTIONS

IMPORTANT SAFETY INFORMATION - READ, FOLLOW, AND SAVE ALL SAFETY AND INSTALLATION INSTRUCTIONS

- Product must be installed by a qualified person in a manner consistent with its intended use and in compliance with the National Electrical Code, Canadian Electrical Code, and all Local and Provincial Codes.
- Follow product label information and instructions.
- Qualified Personnel with appropriate personal protective equipment must perform all servicing of this product.
- Before wiring to power supply and during servicing, turn off and lock out power at fuse or circuit breaker before service.
- The use of accessory equipment not recommended by the manufacturer or installed contrary to instructions may cause an unsafe condition. The use of damaged components may cause an unsafe condition and void product warranty.
- Do not block light emanating from product in whole or part, as this may cause an unsafe condition.
- Never operate the fixture with missing or damaged lens. Lens must be cleaned on regular basis.
- Entire fixture may become extremely hot. Do not touch hot lens or fixture body.
- Replace LED assembly only with correct wattage and type of power supply appropriate for LED assembly.
- All gaskets, o-rings and sealing surfaces must be kept clean during installation and service; failure to do this may cause an unsafe condition and void product warranty.

IMPORTANT LISTINGS AND CERTIFICATIONS

- Suitable for wet locations • Additionally suitable for mounting within 4 ft. of the ground

L.O.C.K. Knuckle - (Locking 'O' Ring Compression Knuckle)

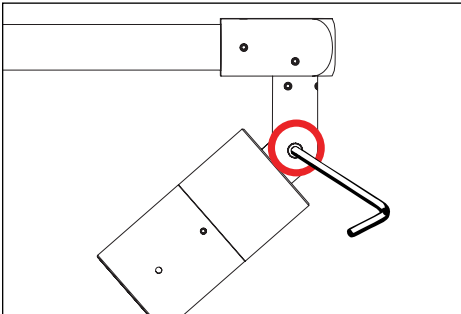

1. Use a 5/32" allen wrench to slightly loosen #10-32 stainless steel set screw on the stem for 180° aiming purpose.

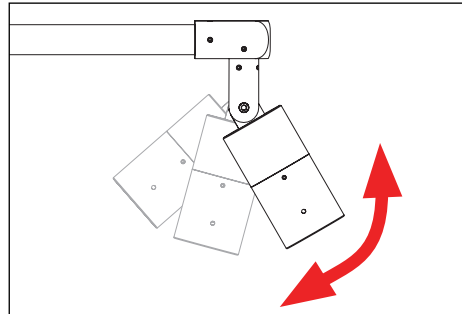

2. Aim fixture to desired angle.

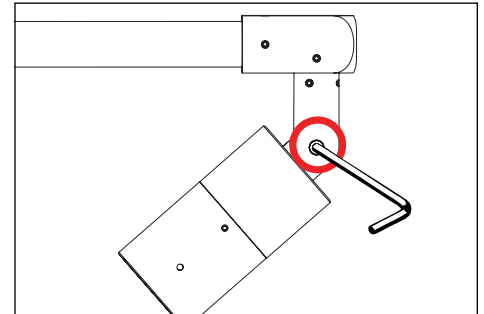

3. Tighten #10-32 stainless steel set screw using a 5/32" allen wrench to secure aiming position.

⚠ Warning: Do not over tighten set screw. Doing so will compromise o-ring seal and will void warranty.

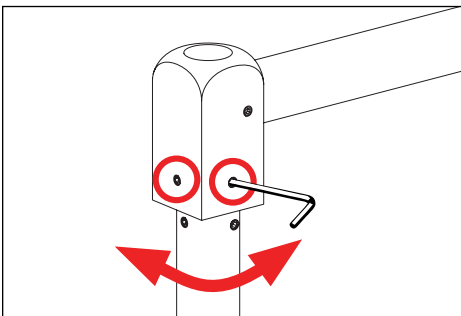

4. To adjust stem horizontally, loosen two (2) #8-32 screws at base of stem cap using a 5/64" allen wrench. Adjust as needed, then secure.

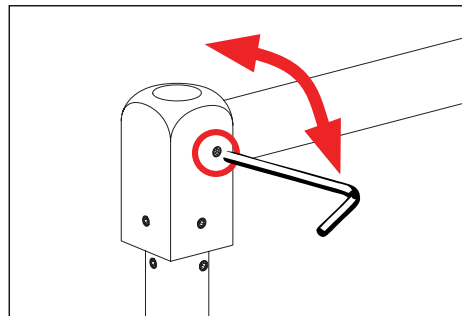

5. To adjust stem, loosen #8-32 screw with a 5/64" allen wrench at stem cap. Adjust as needed, then secure.

IMPORTANT SAFETY INFORMATION - READ, FOLLOW, AND SAVE THESE INSTALLATION INSTRUCTIONS

B-K LIGHTING

40429 Brickyard Drive • Madera, CA 93636 • USA
559.438.5800 • FAX 559.438.5900
www.bklighting.com • info@bklighting.com

RELEASE DATE
03/16/2026

REFERENCE NUMBER
INS-2164-01

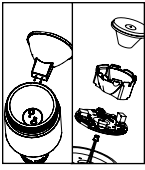

NITE STAR

LED BOARD & OPTICS/MR16 LED LAMP REPLACEMENT

Standard Installation/Replacement



Flammable



Warning



Low Voltage



Hot Surface

TOOLS NEEDED:

- 5/64" & 9/64" Allen Wrench
- Small Flat Head Screwdriver
- Phillips Screwdriver

INSTRUCTIONS PERTAINING TO A RISK OF FIRE, OR INJURY TO PERSONS IMPORTANT SAFETY INSTRUCTIONS

Lighted fixture is HOT!

WARNING - To reduce the risk of FIRE OR INJURY TO PERSONS:

Turn off/unplug and allow to cool before replacing lamp/LED. Fixture gets HOT quickly! Contact only switch/plug when turning on. Do not touch hot lens, guard, or enclosure. Keep fixture away from materials that may burn. Do not operate the luminaire fitting with a missing or damaged shield. Do not touch the source at any time. Use a soft cloth or gloves. Oil from skin may cause damage.

SAVE THESE INSTRUCTIONS

IMPORTANT SAFETY INFORMATION - READ, FOLLOW, AND SAVE ALL SAFETY AND INSTALLATION INSTRUCTIONS

- Product must be installed by a qualified person in a manner consistent with its intended use and in compliance with the National Electrical Code, Canadian Electrical Code, and all Local and Provincial Codes.
- Follow product label information and instructions.
- Qualified Personnel with appropriate personal protective equipment must perform all servicing of this product.
- Before wiring to power supply and during servicing, turn off and lock out power at fuse or circuit breaker before service.
- The use of accessory equipment not recommended by the manufacturer or installed contrary to instructions may cause an unsafe condition. The use of damaged components may cause an unsafe condition and void product warranty.
- Do not block light emanating from product in whole or part, as this may cause an unsafe condition.
- Never operate the fixture with missing or damaged lens. Lens must be cleaned on regular basis.
- Entire fixture may become extremely hot. Do not touch hot lens or fixture body.
- Replace LED assembly only with correct wattage and type of power supply appropriate for LED assembly.
- All gaskets, o-rings and sealing surfaces must be kept clean during installation and service; failure to do this may cause an unsafe condition and void product warranty.

IMPORTANT LISTINGS AND CERTIFICATIONS

Replacing LED Board/Driver and Optics

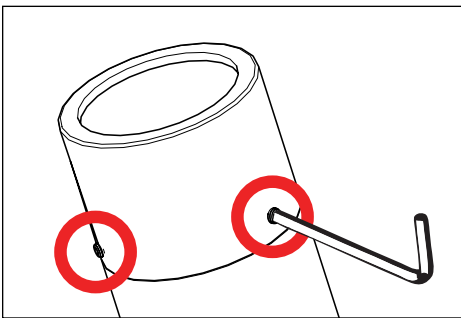

1. Remove cap by loosening three (3) #8-32 set screws using a 5/64" allen wrench. **Do not fully remove set screws**

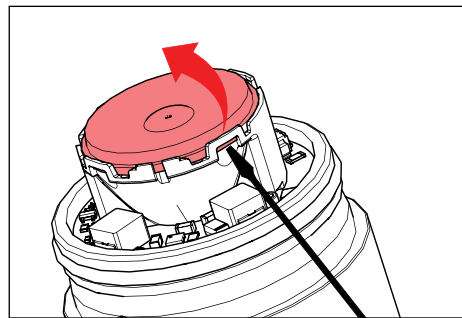

2. Use a flat head screwdriver to gently remove optic from holder.

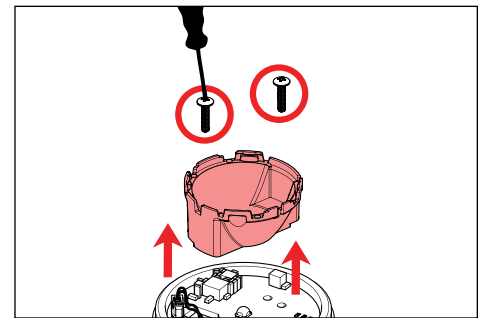

3. Remove optic holder by removing two (2) #2-56 screws using a phillips screwdriver.

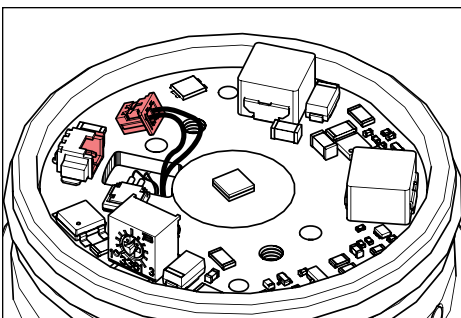

4. Disengage LED board. Replace with new board.

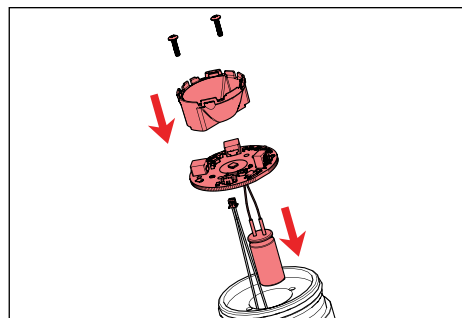

5. Reverse install LED board and optic holder. Carefully reconnect connector to LED and re-install. Re-install optic holder and gently snap optic into holder.

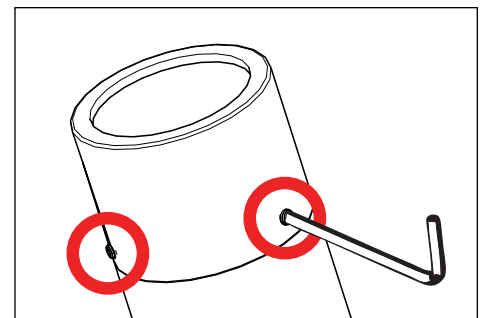

6. Re-install cap onto fixture. Secure by tightening three (3) #8-32 set screws using a 5/64" allen wrench. Top of set screws should sit flush with cap.

⚠ Warning: Do not over tighten set screws. Cap should be able to rotate without using force. Over tightening set screws will compromise o-ring seal and will void warranty.

IMPORTANT SAFETY INFORMATION - READ, FOLLOW, AND SAVE THESE INSTALLATION INSTRUCTIONS

B-K LIGHTING

40429 Brickyard Drive • Madera, CA 93636 • USA
559.438.5800 • FAX 559.438.5900
www.bklighting.com • info@bklighting.com

RELEASE DATE
03/16/2026

REFERENCE NUMBER
INS-2902-00

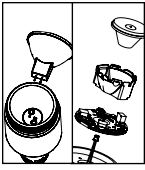

Standard Installation/Replacement

Change Lumen Output

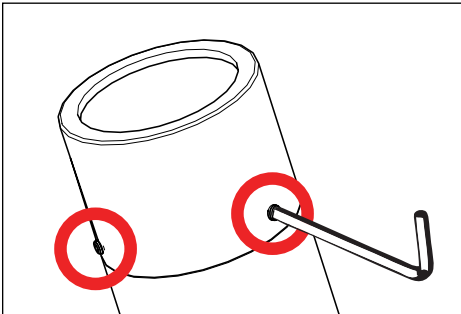

1. Use a 5/64" allen wrench to loosen #8-32 stainless set screw and remove cap.

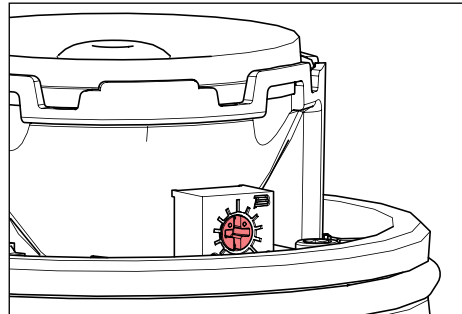

2. With flat head screwdriver rotate dial to desired lumen output.

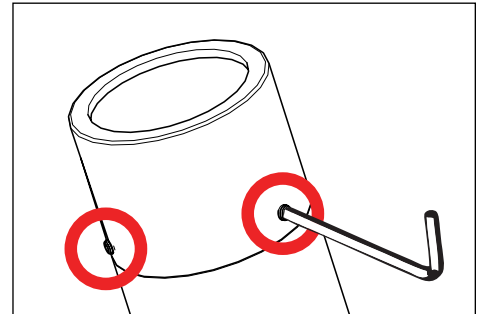

3. Place cap on fixture and tighten set screw. Tighten screw to 1/2 in-lbs. Top of screw should sit flush with fixture cap.

Warning: Do not over tighten set screw. Cap has to be able to move without using force. Doing so will compromise o-ring seal and will void warranty. Cap should be able to rotate without force.

Lamp Installation or Relamping if Required for Low Voltage LED Lamps

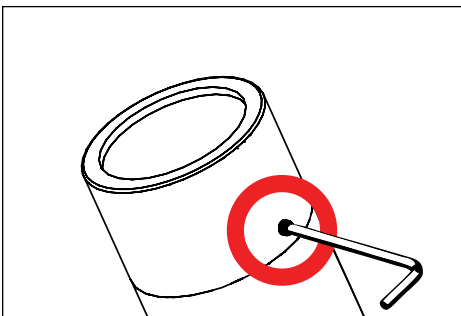

1. Use a 5/64" allen wrench to loosen #8-32 stainless set screw and remove cap.

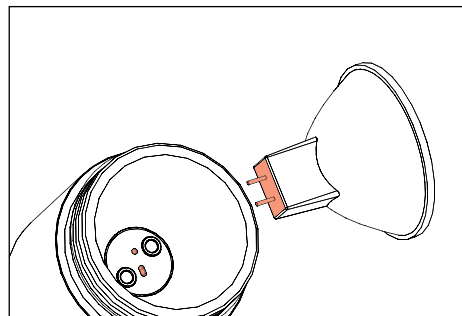

2. Firmly insert lamp pins into socket to make connection. Rocking motion may be required.

Warning: Do not exceed the maximum wattage listed on the fixture label before installing.

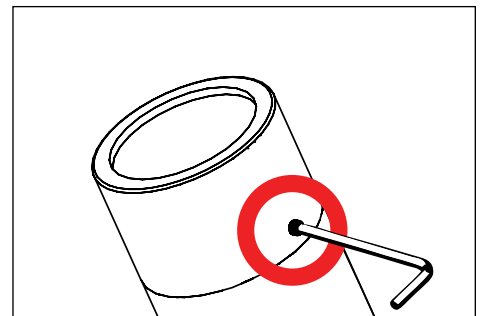

3. Place cap on fixture and tighten set screw. Tighten screw to 1/2 in-lbs. Top of screw should sit flush with fixture cap.

Warning: Do not over tighten set screw. Doing so will compromise o-ring seal and will void warranty.

**IMPORTANT SAFETY INFORMATION LISTED ON REVERSE
READ, FOLLOW, AND SAVE ALL SAFETY AND INSTALLATION INSTRUCTIONS**

